

Programmable Terminal

NA-series

Device Connection

User's Manual

NA5-15W101

NA5-12W101

NA5-9W001

NA5-7W001



© OMRON, 2014

All rights reserved. No part of this publication may be reproduced, stored in a retrieval system, or transmitted, in any form, or by any means, mechanical, electronic, photocopying, recording, or otherwise, without the prior written permission of OMRON.

No patent liability is assumed with respect to the use of the information contained herein. Moreover, because OMRON is constantly striving to improve its high-quality products, the information contained in this manual is subject to change without notice. Every precaution has been taken in the preparation of this manual. Nevertheless, OMRON assumes no responsibility for errors or omissions. Neither is any liability assumed for damages resulting from the use of the information contained in this publication.

Trademarks

- Sysmac and SYSMAC are trademarks or registered trademarks of OMRON Corporation in Japan and other countries for OMRON factory automation products.
- Windows, Windows XP, Windows Vista, Windows 7, Windows 8, Excel, and Visual Basic are registered trademarks of Microsoft Corporation in the USA and other countries.
- EtherCAT® is registered trademark and patented technology, licensed by Beckhoff Automation GmbH, Germany.
- ODVA, CIP, CompoNet, DeviceNet, and EtherNet/IP are trademarks of ODVA.
- The SD and SDHC logos are trademarks of SD-3C, LLC. 
- Portions of this software are copyright 2014 The FreeType Project (www.freetype.org). All rights reserved.

Other company names and product names in this document are the trademarks or registered trademarks of their respective companies.

Introduction

Thank you for purchasing an NA-series Programmable Terminal.

This manual contains information that is necessary to use the NA-series Programmable Terminal. Please read this manual and make sure you understand the functionality and performance of the NA-series Programmable Terminal before you attempt to use it in a control system.

Keep this manual in a safe place where it will be available for reference during operation.

Intended Audience

This manual is intended for the following personnel, who must also have knowledge of electrical systems (an electrical engineer or the equivalent).

- Personnel in charge of introducing FA systems.
- Personnel in charge of designing FA systems.
- Personnel in charge of installing and maintaining FA systems.
- Personnel in charge of managing FA systems and facilities.

Applicable Products

This manual covers the following products.

- NA-series Programmable Terminals

Relevant Manuals

The basic information required to use an NA-series PT is provided in the following three manuals.

- *NA-series Programmable Terminal Hardware User's Manual* (Cat. No. V117)
- *NA-series Programmable Terminal Software User's Manual* (Cat. No. V118)
- *NA-series Programmable Terminal Device Connection User's Manual* (Cat. No. V119)

Operations are performed from the Sysmac Studio Automation Software.

Refer to the *Sysmac Studio Version 1 Operation Manual* (Cat. No. W504) for information on the Sysmac Studio.

Other manuals are necessary for specific system configurations and applications.

The following manual is also available to walk you through installations and operations up to starting actual operation using simple examples.

Refer to it as required.

- *NA-series Programmable Terminal Startup Guide Manual* (Cat. No. V120)

Manual Structure

Page Structure and Markings

The following page structure is used in this manual.

Level 1 heading — 3 Installation and Wiring

Level 2 heading — 3-3 Installing NA-series PTs

Level 3 heading — 3-3-1 Installation in a Control Panel

Give the current headings.

Page tab — 3 Gives the number of the main section.

A step in a procedure — 1 Open a hole in which to embed the NA-series PT with the following dimensions and insert the NA-series PT from the front side of the panel. Indicates a procedure.

Special information — Additional Information Icons indicate precautions, additional information, or reference information.

Manual name — NA Series Programmable Terminal Hardware User's Manual (V117) 3 - 5

Model	Dimensions
NA5-15W□□□□	392 ^{+1/-0} × 268 ^{+1/-0} mm (horizontal × vertical)
NA5-12W□□□□	310 ^{+1/-0} × 221 ^{+1/-0} mm (horizontal × vertical)
NA5-9W□□□□	261 ^{+1/-0} × 166 ^{+1/-0} mm (horizontal × vertical)
NA5-7W□□□□	197 ^{+0.5/-0} × 141 ^{+0.5/-0} mm (horizontal × vertical)

Model	Number of Panel Mounting Brackets
NA5-15W□□□□	8 locations
NA5-12W□□□□	6 locations
NA5-9W□□□□	4 locations
NA5-7W□□□□	4 locations

Note This illustration is provided only as a sample. It may not literally appear in this manual.

Special Information

Special information in this manual is classified as follows:



Precautions for Safe Use

Precautions on what to do and what not to do to ensure safe usage of the product.



Precautions for Correct Use

Indicates precautions on what to do and what not to do to ensure proper operation and performance.



Additional Information

Additional information to read as required.

This information is provided to increase understanding or make operation easier.



Version Information

Information on differences in specifications and functionality with different versions is given.

Sections in this Manual

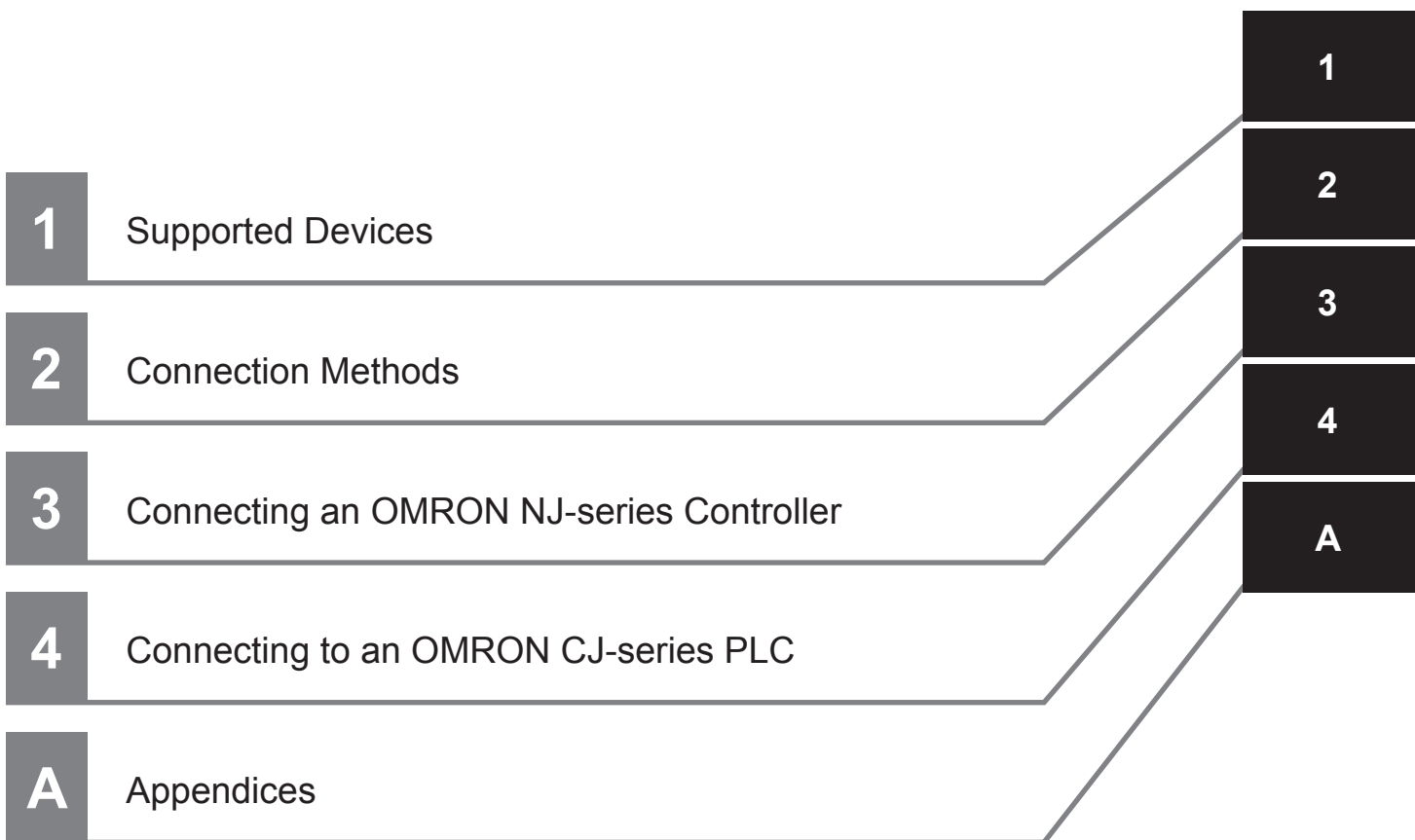

CONTENTS

Introduction.....	1
Relevant Manuals.....	2
Manual Structure.....	3
Sections in this Manual.....	5
Terms and Conditions Agreement	9
Safety Precautions.....	11
Precautions for Safe Use	13
Precautions for Correct Use	16
Regulations and Standards	17
Related Manuals.....	19
Terminology.....	23
Revision History.....	24

Section 1 Supported Devices

1-1 Supported Devices	1-2
-----------------------------	-----

Section 2 Connection Methods

2-1 System Configuration	2-2
2-1-1 System Configuration	2-2
2-1-2 Outline of Settings for Connected Devices and HMIs.....	2-3
2-1-3 Devices Required for Network Configuration.....	2-3
2-2 Network Installation	2-6
2-2-1 Basic Installation Precautions.....	2-6
2-2-2 Precautions on Laying Twisted-pair Cable	2-6
2-2-3 Ethernet Switch Installation Environment Precautions	2-6
2-2-4 Ethernet Switch Connection Methods.....	2-7

Section 3 Connecting an OMRON NJ-series Controller

3-1 Connecting via Ethernet	3-2
3-1-1 NJ-series Controller Settings.....	3-2
3-1-2 HMI Settings	3-3

Section 4 Connecting to an OMRON CJ-series PLC

4-1	Connecting via Ethernet (FINS)	4-2
4-1-1	Making Settings for the CJ-series PLC	4-2
4-1-2	Settings for the HMI	4-5
4-2	Connecting via EtherNet/IP	4-12
4-2-1	EtherNet/IP.....	4-12
4-2-2	Settings for the CJ-series PLC.....	4-12
4-2-3	Settings for the HMI	4-14

Appendix

A-1	Clipboard Format for Device Variable Table Data	A-2
------------	--	------------

Index

Terms and Conditions Agreement

Warranty, Limitations of Liability

Warranties

- **Exclusive Warranty**

Omron's exclusive warranty is that the Products will be free from defects in materials and workmanship for a period of twelve months from the date of sale by Omron (or such other period expressed in writing by Omron). Omron disclaims all other warranties, express or implied.

- **Limitations**

OMRON MAKES NO WARRANTY OR REPRESENTATION, EXPRESS OR IMPLIED, ABOUT NON-INFRINGEMENT, MERCHANTABILITY OR FITNESS FOR A PARTICULAR PURPOSE OF THE PRODUCTS. BUYER ACKNOWLEDGES THAT IT ALONE HAS DETERMINED THAT THE PRODUCTS WILL SUITABLY MEET THE REQUIREMENTS OF THEIR INTENDED USE.

Omron further disclaims all warranties and responsibility of any type for claims or expenses based on infringement by the Products or otherwise of any intellectual property right.

- **Buyer Remedy**

Omron's sole obligation hereunder shall be, at Omron's election, to (i) replace (in the form originally shipped with Buyer responsible for labor charges for removal or replacement thereof) the non-complying Product, (ii) repair the non-complying Product, or (iii) repay or credit Buyer an amount equal to the purchase price of the non-complying Product; provided that in no event shall Omron be responsible for warranty, repair, indemnity or any other claims or expenses regarding the Products unless Omron's analysis confirms that the Products were properly handled, stored, installed and maintained and not subject to contamination, abuse, misuse or inappropriate modification. Return of any Products by Buyer must be approved in writing by Omron before shipment. Omron Companies shall not be liable for the suitability or unsuitability or the results from the use of Products in combination with any electrical or electronic components, circuits, system assemblies or any other materials or substances or environments. Any advice, recommendations or information given orally or in writing, are not to be construed as an amendment or addition to the above warranty.

See <http://www.omron.com/global/> or contact your Omron representative for published information.

Limitation on Liability; Etc

OMRON COMPANIES SHALL NOT BE LIABLE FOR SPECIAL, INDIRECT, INCIDENTAL, OR CONSEQUENTIAL DAMAGES, LOSS OF PROFITS OR PRODUCTION OR COMMERCIAL LOSS IN ANY WAY CONNECTED WITH THE PRODUCTS, WHETHER SUCH CLAIM IS BASED IN CONTRACT, WARRANTY, NEGLIGENCE OR STRICT LIABILITY.

Further, in no event shall liability of Omron Companies exceed the individual price of the Product on which liability is asserted.

Application Considerations

Suitability of Use

Omron Companies shall not be responsible for conformity with any standards, codes or regulations which apply to the combination of the Product in the Buyer's application or use of the Product. At Buyer's request, Omron will provide applicable third party certification documents identifying ratings and limitations of use which apply to the Product. This information by itself is not sufficient for a complete determination of the suitability of the Product in combination with the end product, machine, system, or other application or use. Buyer shall be solely responsible for determining appropriateness of the particular Product with respect to Buyer's application, product or system. Buyer shall take application responsibility in all cases.

NEVER USE THE PRODUCT FOR AN APPLICATION INVOLVING SERIOUS RISK TO LIFE OR PROPERTY WITHOUT ENSURING THAT THE SYSTEM AS A WHOLE HAS BEEN DESIGNED TO ADDRESS THE RISKS, AND THAT THE OMRON PRODUCT(S) IS PROPERLY RATED AND INSTALLED FOR THE INTENDED USE WITHIN THE OVERALL EQUIPMENT OR SYSTEM.

Programmable Products

Omron Companies shall not be responsible for the user's programming of a programmable Product, or any consequence thereof.

Disclaimers

Performance Data

Data presented in Omron Company websites, catalogs and other materials is provided as a guide for the user in determining suitability and does not constitute a warranty. It may represent the result of Omron's test conditions, and the user must correlate it to actual application requirements. Actual performance is subject to the Omron's Warranty and Limitations of Liability.

Change in Specifications

Product specifications and accessories may be changed at any time based on improvements and other reasons. It is our practice to change part numbers when published ratings or features are changed, or when significant construction changes are made. However, some specifications of the Product may be changed without any notice. When in doubt, special part numbers may be assigned to fix or establish key specifications for your application. Please consult with your Omron's representative at any time to confirm actual specifications of purchased Product.

Errors and Omissions

Information presented by Omron Companies has been checked and is believed to be accurate; however, no responsibility is assumed for clerical, typographical or proofreading errors or omissions.

Safety Precautions

Definition of Precautionary Information

The following notation is used in this manual to provide precautions required to ensure safe usage of the NA-series Programmable Terminal. The safety precautions that are provided are extremely important to safety. Always read and heed the information provided in all safety precautions.

The following notation is used.



WARNING

Indicates a potentially hazardous situation which, if not avoided, could result in mild or moderate injury or at the worst, serious injury or death. Additionally, there may be severe property damage.



Caution

Indicates a potentially hazardous situation which, if not avoided, may result in minor or moderate injury, or property damage.



Precautions for Safe Use

Indicates precautions on what to do and what not to do to ensure safe usage of the product.



Precautions for Correct Use

Indicates precautions on what to do and what not to do to ensure proper operation and performance.

Symbols



The circle and slash symbol indicates operations that you must not do.
The specific operation is shown in the circle and explained in text.
This example indicates prohibiting disassembly.



The triangle symbol indicates precautions (including warnings).
The specific operation is shown in the triangle and explained in text.
This example indicates a general precaution.

Warnings



WARNING

Do not attempt to take the NA Unit apart and do not touch the product inside while the power is being supplied. Otherwise it may result in electric shock.



Always ensure that the personnel in charge confirm that installation, inspection, and maintenance were properly performed for the NA Unit. "Personnel in charge" refers to individuals qualified and responsible for ensuring safety during machine design, installation, operation, maintenance, and disposal.



Ensure that installation and post-installation checks are performed by personnel in charge who possess a thorough understanding of the machinery to be installed.



Do not use the input functions such as the touch panel or function keys of the NA Unit, in applications that involve human life, in applications that may result in serious injury, or for emergency stop switches.

Do not attempt to disassemble, repair, or modify the NA Unit. It may cause NA Unit to lose its safety function.



Never press two points or more on the touch panel of the NA Unit at a time. Touching two points or more interrupts normal touch panel operations.

Precautions for Safe Use

- When unpacking the NA Unit, check carefully for any external scratches or other damages. Also, shake the NA Unit gently and check for any abnormal sound.
- The NA Unit must be installed in a control panel.
- The mounting panel must be between 1.6 and 6.0 mm thick. Tighten the Mounting Brackets evenly to a torque of between 0.5 and 0.6 N·m to maintain water and dust resistance. If the tightening torque exceeds the specified value, or the tightening is not even, deformation of the front panel may occur. What is more, make sure the panel is not dirty or warped and that it is strong enough to hold the NA Unit.
- Do not let metal particles enter the NA Unit when preparing the panel.
- Turn OFF the power supply before connecting or disconnecting cables.
- Periodically check the installation conditions in applications where the NA Unit is subject to contact with oil or water.
- Be certain to use the cables with lock mechanism such as serial cable or the Ethernet cable after confirming if it is securely locked.
- Do not touch the packaging part of the circuit board with your bare hands. Discharge any static electricity from your body before handling the board.
- Do not use volatile solvents such as benzene and thinners or chemical cloths.
- Water and oil resistance will be lost if the front sheet is torn or is peeling off. Do not use the NA Unit, if the front sheet is torn or is peeling off.
- As the rubber packing will deteriorate, shrink, or harden depending on the operating environment, periodical inspection is necessary.
- Confirm the safety of the system before turning ON or OFF the power supply, or pressing the reset switch.
- The whole system may stop depending on how the power supply is turned ON or OFF. Turn ON/OFF the power supply according to the specified procedure.
- Operate DIP switch according to the following way.

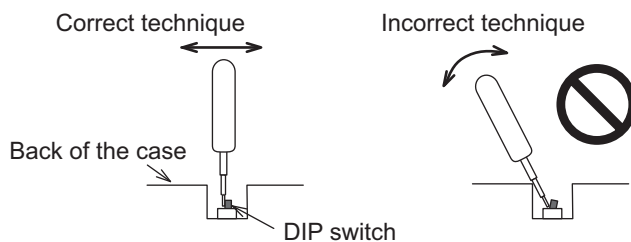

The DIP switch may break if it is levered with a tool against the case as shown in the figure.

- Once the DIP switch settings are changed, reset by pressing the reset switch, or restart the power supply.
- Initialize the project, after confirming that existing project is backed up at the Sysmac Studio.
- When changing the password, do not reset or turn OFF the power supply until the writing is completed. A failure to store the password may cause the project to fail to function.
- While uploading or downloading a project or a system program, do not perform the operations as follows. Such operations may corrupt the project or the system program:
 - Turning OFF the power supply of the NA Unit
 - Resetting the NA Unit.
 - Removing the USB devices or SD card.
 - Disconnecting the cable between a support tool and the NA Unit.
- Do not connect an AC power supply to the DC power terminals.
- Do not perform a dielectric strength test.

- Use a DC power with a slight voltage fluctuation and that will provide a stable output even if the input is momentarily interrupted for 10 ms. Also use the one with reinforced insulation or double insulation. Rated Power Supply Voltage: 24VDC (Allowable range 19.2 to 28.8VDC)
- Use a power cable with AWG#12 to #22 thick (0.35mm² to 3.31mm²). Peel the coating 7mm length and tighten the terminal screw with the torque in the range of 0.5 to 0.6 N·m. Also confirm if the terminal screw is tighten appropriately.
- To prevent malfunctions caused by noise, ground the NA Unit correctly.
- Do not use any battery if strong impact is applied to it (e.g. by dropping on the floor) because such a battery may cause a leakage.
- Confirm the type of the battery to install the battery properly.
- Apply power for at least five minutes before changing the battery. Mount a new battery within five minutes after turning OFF the power supply. If power is not supplied for at least five minutes, the clock data may be lost. Check the clock data after changing the battery.
- Do not dismantle a battery nor let it short-circuit.
- Do not apply an impact with the lithium battery, charge it, dispose it into a fire, or heat it. Doing either of them may cause an ignition or a bursting.
- Dispose of the NA Units and batteries according to local ordinances as they apply.



- The following precaution must be displayed on all products containing lithium primary batteries with a perchlorate content of 6ppb or higher when exporting them to or shipping them through California, USA.

Perchlorate Material - special handling may apply.

See www.dtsc.ca.gov/hazardouswaste/perchlorate

The NA-Series contains a lithium primary battery with a perchlorate content of 6ppb or higher. When exporting a product containing the NA-Series to or shipping such a product through California, USA, label all packing and shipping containers appropriately.

- Do not connect the USB devices in the environment subject to the strong vibration.
- Do not connect USB devices which are not allowed to connect to NA Unit.
- Start actual system application only after checking normal operation of the system including storage devices such as USB memory and SD card.
- When connecting peripheral devices which do not meet the performance level of the NA Unit for noise and static electricity, ensure sufficient countermeasures against noise and static electricity during installation of the peripheral devices to the NA Unit.
- Do not carry out the following operations when accessing USB devices or SD card:
 - Turning OFF the power supply of the NA Unit
 - Press the Reset switch of the NA Unit
 - Pull out the USB devices or SD card
- When using the No. 6 pin of the serial port connector for a voltage of DC+5V, make sure the supply equipment's current capacity is below 250mA before using it. The DC+5V voltage output of the NA Unit is +5V±5%, and the maximum current is 250mA.
- To ensure the system's safety, make sure to incorporate a program that call periodically signals during the operation at connected device side and can confirm the normal functionality of the NA Unit before running the system.
- Start actual system application only after sufficiently checking project, subroutine and the operation of the program at the connected device side.
- To use numeric input functions safely, always make maximum and minimum limit settings.
- Do not press the touch panel with a force greater than 30 N.
- Do not use hard or pointed objects to operate or scrub the screen, otherwise the surface of the screen may be damaged.

- The deterioration over time may cause the touch points to move on the touch panel. Calibrate the touch panel periodically.
- A touch position detection error of approximately 20 pixels may occur due to the precision of the touch panel. Always take this into account when positioning objects on the panel so adjoining objects will not be activated by mistake.
- Confirm the safety of the system before pressing the touch panel.
- Do not accidentally press the touch panel when the backlight is not lit or when the display does not appear or is too dark to identify visually.
- You can change the brightness by changing the setting such as in the system menu or by downloading project.
If the brightness is set to very dark, it causes flickering or unreadable screen. Additionally, the brightness can be restored by transferring the project again after setting the property of the brightness appropriately.
In a case of the applications where end users can control the brightness, create the applications so as keeping on operations by such as assigning the function which restores the brightness to one of function keys, if necessary.
- Signals from the touch panel may not be entered if the touch panel is pressed consecutively at high speed. Make sure to go on the next operation after confirming that the NA Unit has detected the input of the touch panel.
- The function keys have the restrictions as follows:
 - Using both anti-reflection sheet and protective cover interrupts the normal function key operation. Do not use them together.
 - When you use gloves or others, the function keys may not work correctly depending on the material and thickness of the gloves. Take actual conditions of the gloves usage into considerations prior to the system startup to perform the confirmation.
 - The function keys do not work when covered with water. Remove the water completely before use.

Precautions for Correct Use

- **Do not install or store the NA Unit in any of the following locations:**

- Locations subject to severe changes in temperature
- Locations subject to temperatures or humidity outside the range specified in the specifications
- Locations subject to condensation as the result of high humidity
- Locations subject to corrosive or flammable gases
- Locations subject to strong shock or vibration
- Locations outdoors subject to direct wind and rain
- Locations subject to strong ultraviolet light
- Locations subject to dust
- Locations subject to direct sunlight
- Locations subject to splashing oil or chemicals

- **Take appropriate and sufficient countermeasures when installing systems in the following locations:**

- Locations subject to static electricity or other forms of noise
- Locations subject to strong electric field or magnetic field
- Locations close to power supply lines
- Locations subject to possible exposure to radioactivity

Regulations and Standards

Conformance to EC Directives

Applicable Directives

- EMC Directive

Concepts

● EMC Directive

OMRON devices that comply with EC Directives also conform to the related EMC standards so that they can be more easily built into other devices or the overall machine. The actual products have been checked for conformity to EMC standards.*

Whether the products conform to the standards in the system used by the customer, however, must be checked by the customer. EMC-related performance of the OMRON devices that comply with EC Directives will vary depending on the configuration, wiring, and other conditions of the equipment or control panel on which the OMRON devices are installed. The customer must, therefore, perform the final check to confirm that devices and the overall machine conform to EMC standards.

- * Applicable EMC (Electromagnetic Compatibility) standards are as follows:
EMS (Electromagnetic Susceptibility): EN 61131-2:2007
EMI (Electromagnetic Interference): EN 61131-2:2007

● Conformance to EC Directives

The NA-series PTs comply with EC Directives. To ensure that the machine or device in which the NA-series PT is used complies with EC Directives, the NA-series PT must be installed as follows:

- The NA Unit must be installed within a control panel.
- You must use reinforced insulation or double insulation for the DC power supplies connected to the NA Unit.
- NA-series PTs that comply with EC Directives also conform to the Common Emission Standard (EN 61000-6-4). Radiated emission characteristics (10-m regulations) may vary depending on the configuration of the control panel used, other devices connected to the control panel, wiring, and other conditions.
You must therefore confirm that the overall machine or equipment complies with EC Directives.
- This is a Class A product (for industrial environments). In a residential environment, it may cause radio interference, in which case the user may be required to take appropriate measures.

Conformance to KC Standards

Observe the following precaution if you use NA-series PTs in Korea.

A 급 기기 (업무용 방송통신기자재)

이 기기는 업무용(A 급) 전자파적합기기로서 판매자 또는 사용자는 이 점을 주의하시기 바라며, 가정외의 지역에서 사용하는 것을 목적으로 합니다.

Class A Device (Broadcasting Communications Device for Business Use)

This device obtained EMC registration for office use (Class A), and it is intended to be used in places other than homes. Sellers and/or users need to take note of this.

Related Manuals

The following manuals are related to the NA-series PTs. Use these manuals for reference.

Manual name	Cat. No.	Models	Applications	Description
NA-series Programmable Terminal Hardware User's Manual	V117	NA5-□W□□□□	Learning the specifications and settings required to install an NA-series PT and connect peripheral devices.	Information is provided on NA-series PT specifications, part names, installation procedures, and procedures to connect an NA Unit to peripheral devices. Information is also provided on maintenance after operation and troubleshooting.
NA-series Programmable Terminal Software User's Manual	V118	NA5-□W□□□□	Learning about NA-series PT pages and object functions.	NA-series PT pages and object functions are described.
NA-series Programmable Terminal Device Connection User's Manual	V119	NA5-□W□□□□	Learning the specifications required to connect devices to an NA-series PT.	Information is provided on connection procedures and setting procedures to connect an NA-series PT to a Controller or other device.
NA-series Programmable Terminal Startup Guide	V120	NA5-□W□□□□	Learning in concrete terms information required to install and start the operation of an NA-series PT.	The part names and installation procedures are described followed by page creation and transfer procedures with the Sysmac Studio. Also operation, maintenance, and inspection procedures after the project is transferred are described. Sample screen captures are provided as examples.
NJ-series CPU Unit Hardware User's Manual	W500	NJ501-□□□□ NJ301-□□□□	Learning the basic specifications of the NJ-series CPU Units, including introductory information, designing, installation, and maintenance. Mainly hardware information is provided.	An introduction to the entire NJ-series system is provided along with the following information on a Controller built with a CPU Unit. <ul style="list-style-type: none"> • Features and system configuration • Introduction • Part names and functions • General specifications • Installation and wiring • Inspection and maintenance Use this manual together with the <i>NJ-series CPU Unit Software User's Manual</i> (Cat. No. W501).

Manual name	Cat. No.	Models	Applications	Description
NJ-series CPU Unit Software User's Manual	W501	NJ501-□□□□ NJ301-□□□□	Learning how to program and set up an NJ-series CPU Unit. Mainly software information is provided.	Provides the following information on a Controller built with an NJ-series CPU Unit. <ul style="list-style-type: none"> • CPU Unit operation • CPU Unit features • Initial settings • Programming based on IEC 61131-3 language specifications Use this manual together with the <i>NJ-series CPU Unit Hardware User's Manual</i> (Cat. No. W500).
CJ Series Programmable Controllers Operation Manual	W393	CJ1H-CPU□□H-R CJ1G/H-CPU□□H CJ1G-CPU□□P CJ1M-CPU□□ CJ1G-CPU□□	Learning the basic specifications of the CJ-series PLCs, including introductory information, designing, installation, and maintenance.	The following information is provided on a CJ-series PLC. <ul style="list-style-type: none"> • Introduction and features • System configuration design • Installation and wiring • I/O memory allocation • Troubleshooting Use this manual together with the <i>Programming Manual</i> (Cat. No. W394).
CS/CJ/NSJ Series Programmable Controllers Operation Manual	W394	CS1G/H-CPU□□H CS1G/H-CPU□□-V1 CS1D-CPU□□H CS1D-CPU□□S CJ1H-CPU□□H-R CJ1G/H-CPU□□H CJ1G-CPU□□P CJ1M-CPU□□ CJ1G-CPU□□ NSJ□-□□□□(B)-G5D NSJ□-□□□□(B)-M3D	Learning about the functions of the CS/CJ-series and NSJ-series PLCs.	The following information is provided on a CS/CJ-series or NSJ-series PLC. <ul style="list-style-type: none"> • Programming • Master function • File memory • Other functions Use this manual together with the <i>Operation Manual</i> (CS-series PLCs: W339, CJ-series PLCs: W393).
CS/CJ/NJ-series Instructions Reference Manual	W340	CS1□-CPU-□□□-□□ CJ1□-CPU-□□□-□□□ CJ2H-CPU-□□□-□□□ NSJ□□-□□□□□-□□□	Learning detailed information on programming instructions.	Instructions are described in detail. When programming, use this manual together with the <i>Operation Manual</i> (CS-series PLCs: W339, CJ-series PLCs: W393) and the <i>Programming Manual</i> (W394).
CS/CJ Series Programming Consoles Operation Manual	W341	CQM1H-PRO01 CQM1-PRO01 C200H-PRO27 +CS1W-KS001	Learning the operating procedures of the Programming Consoles.	The operating procedures of the Programming Consoles are described. When programming, use this manual together with the <i>Operation Manual</i> (CS-series PLCs: W339, CJ-series PLCs: W393), the <i>Programming Manual</i> (W394), and the <i>Instructions Reference Manual</i> (W340).

Manual name	Cat. No.	Models	Applications	Description
CS/CJ/NSJ Series Communications Commands Reference Manual	W342	CS1G/H-CPU□□H CS1G/H-CPU□□-V1 CS1D-CPU□□H CS1D-CPU□□S CS1W-SCU□□-V1 CS1W-SCB□□-V1 CJ1G/H-CPU□□H CJ1G-CPU□□P CJ1M-CPU□□ CJ1G-CPU□□ CJ1W-SCU□□-V1	Learning detailed specifications on the communications instructions addressed to CS/CJ-series CPU Units and NSJ-series PLCs.	1) C-mode commands and 2) FINS commands are described in detail. Refer to this manual for information on communications commands (C-mode commands and FINS commands) addressed to CPU Units. Note This manual describes communications commands that are addressed to a CPU Unit. The communications path is not relevant. (The communications commands can be sent through the serial communications port of the CPU Unit, the communications port of a Serial Communications Board/Unit, or a communications port on another Communications Unit.)
CJ-series CJ2 CPU Unit Hardware User's Manual	W472	CJ2H-CPU6□-EIP CJ2H-CPU6□ CJ2M-CPU□□	Learning the hardware specifications of CJ2 CPU Units.	The following information is provided on a CJ2 CPU Unit. <ul style="list-style-type: none"> • Introduction and features • Basic system configuration • Part names and functions • Installation and setting procedures • Troubleshooting Use this manual together with the <i>Software User's Manual</i> (Cat. No. W473).
CJ-series CJ2 CPU Unit Software User's Manual	W473	CJ2H-CPU6□-EIP CJ2H-CPU6□ CJ2M-CPU□□	Learning the software specifications of CJ2 CPU Units.	The following information is provided on a CJ2 CPU Unit. <ul style="list-style-type: none"> • CPU Unit operation • Internal memory • Programming • Settings • Functions built into the CPU Unit Use this manual together with the <i>Hardware User's Manual</i> (Cat. No. W472).
Ethernet Units Operation Manual Construction of Networks	W420	CS1W-ETN21 CJ1W-ETN21	Learning how to use an Ethernet Unit.	Information is provided on the Ethernet Units. Information is provided on the basic setup and FINS communications. Refer to the <i>Communications Commands Reference Manual</i> (Cat. No. W342) for details on FINS commands that can be sent to CS/CJ-series CPU Units when using the FINS communications service.

Manual name	Cat. No.	Models	Applications	Description
Ethernet Units Operation Manual Construction of Applications	W421	CS1W-ETN21 CJ1W-ETN21	Learning how to use an Ethernet Unit.	Information is provided on constructing host applications, including functions for sending/receiving mail, socket service, automatic clock adjustment, FTP server functions, and FINS communications.
CS/CJ-series EtherNet/IP™ Units Operation Manual	W465	CJ2H-CPU6□-EIP CJ2M-CPU3□ CS1W-EIP21 CJ1W-EIP21	Learning how to use the built-in EtherNet/IP port of the CJ2 CPU Units.	Information is provided on the built-in EtherNet/IP port and EtherNet/IP Units. Basic settings, tag data links, FINS communications, and other functions are described.
Sysmac Studio Version 1 Operation Manual	W504	SYSMAC-SE2□□□	Learning about the operating procedures and functions of the Sysmac Studio.	The operating procedures of the Sysmac Studio are described.
CX-Programmer Operation Manual	W446	CXONE-AL□□C-V4 CXONE-AL□□D-V4	Learning about the CX-Programmer except for information on function blocks, ST programming, and SFC programming.	The operating procedures of the CX-Programmer are described.

Terminology

Term	Description
HMI	A general term for interface devices that indicates both hardware and software elements. In this manual, "HMI" refers to an OMRON Sysmac-brand product unless otherwise specified.
PT	The hardware elements of the HMI.
NA Series	The NA Series of Programmable Terminals and peripheral devices.
HMI Project	A Sysmac Studio project for an HMI.
NA Unit	An NA-series Programmable Terminal.
Download	Transferring data from the Sysmac Studio to an HMI.
IAG collection	When you provide IAGs, you provide them as IAG collections. IAGs are also imported as IAG collections. An IAG collection contains one or more IAGs.

Revision History

A manual revision code appears as a suffix to the catalog number on the front and back covers of the manual.

Cat. No. V119-E1-01

↑ Revision code

Revision code	Date	Revised content
01	June 2014	Original production



Supported Devices

This section lists the models that can be connected to the NA-series Programmable Terminals.

1-1 Supported Devices 1-2

1-1 Supported Devices

This section lists the devices that can be connected to the NA-series Programmable Terminals.

Manufacturer	Models	Connection method	Communications driver
OMRON	NJ501-□□□□ NJ301-□□□□	Built-in EtherNet/IP port	Ethernet
	CJ2H-CPU64/65/66/67/68-EIP CJ2M-CPU31/32/33/34/35	Built-in EtherNet/IP port	CIP Ethernet
	CJ2H-CPU64/65/66/67/68-EIP CJ2M-CPU31/32/33/34/35	CJ1W-EIP21	
	CJ2H-CPU64/65/66/67/68-EIP CJ2M-CPU31/32/33/34/35	Built-in EtherNet/IP port	FINS Ethernet
	CJ1H-CPU65H/66H/67H CJ1H-CPU65H/66H/67H-R CJ1G-CPU42H/43H/44H/45H CJ1M-CPU11/12/13/21/22/23 CJ2H-CPU64/65/66/67/68(-EIP) CJ2M-CPU11/12/13/14/15 CJ2M-CPU31/32/33/34/35	CJ1W-ETN21 CJ1W-EIP21	

2

Connection Methods

This section describes the required settings for each connection method and the common specifications for network installation.

2-1	System Configuration	2-2
2-1-1	System Configuration	2-2
2-1-2	Outline of Settings for Connected Devices and HMIs	2-3
2-1-3	Devices Required for Network Configuration	2-3
2-2	Network Installation	2-6
2-2-1	Basic Installation Precautions	2-6
2-2-2	Precautions on Laying Twisted-pair Cable	2-6
2-2-3	Ethernet Switch Installation Environment Precautions	2-6
2-2-4	Ethernet Switch Connection Methods	2-7

2-1 System Configuration

This section provides brief descriptions of the system configurations. These system configurations are independent of the connected devices.

2-1-1 System Configuration

You can use the following methods to connect HMIs to devices:

- Connect the HMI directly to a connected device without an Ethernet switch.
- Connect the HMI to connected devices with an Ethernet switch.

With both of the above methods, the connected device is connected via Ethernet port 1.

Connecting the HMI Directly to a Connected Device without an Ethernet Switch

You can connect the HMI to the connected device with a twisted-pair cross cable.

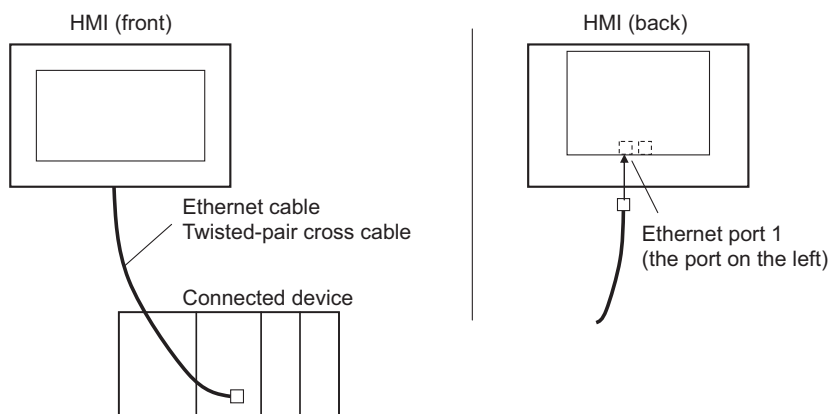

Connecting the HMI to Connected Devices with an Ethernet Switch

You can connect multiple HMIs and connected devices using a twisted-pair straight cable and an Ethernet switch.

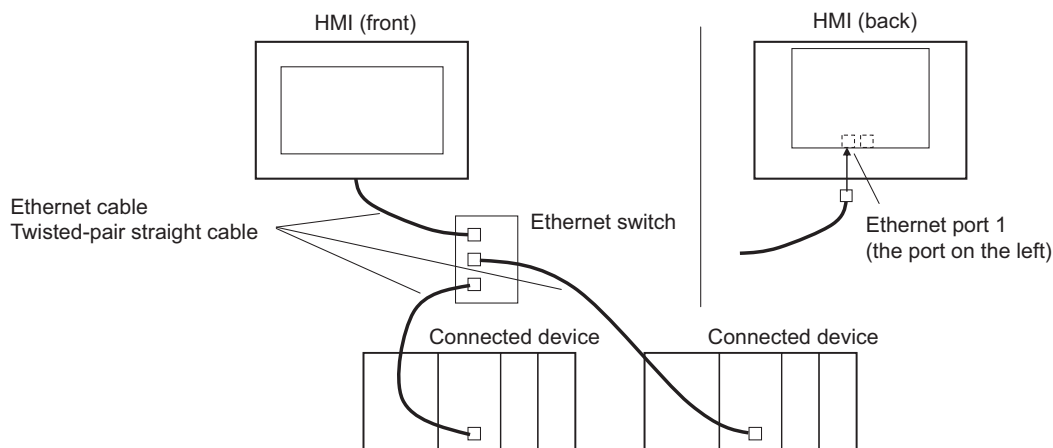

2-1-2 Outline of Settings for Connected Devices and HMIs

The following settings must be made. Detailed definitions vary with each connected device. Refer to Section 3 and later for detailed connected device descriptions.

Connected Device Settings

Set the required parameters, such as the IP addresses, using the setting tools for the connected devices.

Also register required variables if the connected devices support using variables.

Settings for Connection to the HMI

For the Sysmac Studio, you must set parameters for communications, such as the settings for Ethernet port 1, connected device registration, and variable mappings.

● Connecting to an NJ-series Controller That Is Registered in the Current Project

When connecting to an NJ-series Controller registered in a project, registration of connected devices is not necessary. Make the settings required only for communications and variable mapping.

● Connecting to an External Connected Device That Is Not Registered in the Current Project

- Make the settings for communications using the HMI Settings of the Sysmac Studio.
- Register the connected devices using the Device References of the Sysmac Studio. If the connected devices use variables, import the variables and register them as device variables.
- With the Variable Mappings of the Sysmac Studio, allocate the device variables to the global variables.

2-1-3 Devices Required for Network Configuration

The following devices are also required in advance to configure the network using Ethernet and must be purchased separately.

Always use products that conform to the IEEE802.3i, IEEE802.3u, and IEEE802.3ab standards for all network configuration devices.

Network configuration device	Description
Connected device that supports Ethernet	A connected device must support an Ethernet connection.
Ethernet switch	A network device that serves as a central wiring point for multiple terminals
Twisted-pair cable	Cable consisting of four twisted pairs of thin, copper wires in a cross cable or a straight cable.

Recommended Devices for Network Configuration

The following products are recommended for configuring the network using Ethernet.

● Ethernet Switches

- Ethernet Switches Manufactured by OMRON

Model	Specifications ○: Supported, ×: Not supported		
	Description	Number of ports	Failure detection output
W4S1-03B	Packet priority control (QoS): Ether-Net/IP control data priority	3	×
W4S1-05B		5	×
W4S1-05C	Failure detection: Broadcast storm, LSI error detection, 10BASE-T/100BASE-TX, auto-negotiation	5	○

- Ethernet Switches Manufactured by Other Companies

Manufacturer	Model
Cisco Systems, Inc	Consult the manufacturer.
CONTEC USA Inc	Consult the manufacturer.
Phoenix Contact USA	Consult the manufacturer.

● Twisted-pair Cables (100BASE-TX) and Connectors (Modular Plugs and STP Plugs)

Product name	Manufacturer	Model
Sizes and conductor pairs: AWG24 × 4P	Cables	Tonichi Kyosan Cable, Ltd. NETSTAR-C5E SAB 0.5 × 4P
		Kuramo Electric Co., Ltd. KETH-SB
		SWCC Showa Cable Systems Co. FAE-5004
	RJ45 Connector	Panduit Corporation MPS588
Sizes and conductor pairs: 0.5 mm × 4P	Cables	Fujikura Ltd. F-LINK-E 0.5mm × 4P
	RJ45 Connector	Panduit Corporation MPS588

● Boots

Manufacturer	Model
TSUKO	MK Boots (IV) LB



Additional Information

Types of Ethernet Switches

- Unmanaged Layer 2 (L2) Ethernet Switches

This type of Ethernet switch uses the Ethernet addresses to switch ports. Most Ethernet switches provide this function. You cannot switch the functions or change the set values of this type of Ethernet switch.

- Managed Layer 2 (L2) Ethernet Switches

This type of Ethernet switch uses Ethernet addresses to switch ports. However, with this type of Ethernet switch, you can switch functions and change settings with special software tools running on a network node. You can also collect analytical data. This type of Ethernet switch provides more-advanced functions than unmanaged layer 2 Ethernet switches.

Ethernet Switch Functions

This section outlines the Ethernet switch functions that are important for an EtherNet/IP network.

For an EtherNet/IP network, consider whether the Ethernet switch supports these functions when you select an Ethernet switch.

- Presence or absence of multicast filtering
- Presence or absence of QoS (quality of service) for TCP/UDP port numbers (L4)

Multicast Filtering

Multicast filtering transfers multicast packets to the specific nodes only. This function is implemented in the Ethernet switch as IGMP snooping or GMRP. "Specific nodes" are the nodes equipped with an IGMP client that have made transfer requests to the Ethernet switch. (OMRON built-in EtherNet/IP ports are equipped with an IGMP client.) When the Ethernet switch does not use multicast filtering, multicast packets are sent to all nodes, just like broadcast packets, which increases the traffic on the network. Settings must be made in the Ethernet switch to enable this function. There must be enough multicast filters for the network.

QoS (Quality of Service) Function for TCP/UDP Port Numbers (L4)

This function controls the priority of packet transmissions so that packets can be sent with higher priority to a particular IP address or TCP (UDP) port. The TCP and UDP protocols are called transport layer protocols, leading to the name L4 (layer 4) QoS function.

Support for the above two functions is as follows for the different types of Ethernet switches:

Type of Ethernet switch	Multicast filtering	L4 QoS	Remarks
Unmanaged L2 Ethernet switch	None	None	---
Managed L2 Ethernet switch	Provided.	Provided.	Both functions must be set with a special software tool.
OMRON W4S1-series Ethernet Switch	None	Provided.	L4 QoS is set with a switch. No software tool is necessary.

2-2 Network Installation

2-2-1 Basic Installation Precautions

- Take the greatest care when you install the Ethernet system. Be sure to follow ISO/IEC 8802-3 specifications. Be sure you understand them before attempting to install an Ethernet system.
- Unless you are already experienced in installation of communications systems, we strongly recommend that you employ a professional familiar with safety measures and standards to install your system.
- Do not install Ethernet equipment near sources of noise. If a noisy environment is unavoidable, take adequate measures against noise interference, such as installation of network components in metal cases or the use of optical cable in the system.

2-2-2 Precautions on Laying Twisted-pair Cable

- Noise immunity may be reduced by ground loops, which can occur due to improper shield connections and grounding. Ground the shield at one location, as shown in the following diagram.
- Do not connect the shield to the connector on the HMI.
- If a cable connects two Ethernet switches, connect the shield at only one end.

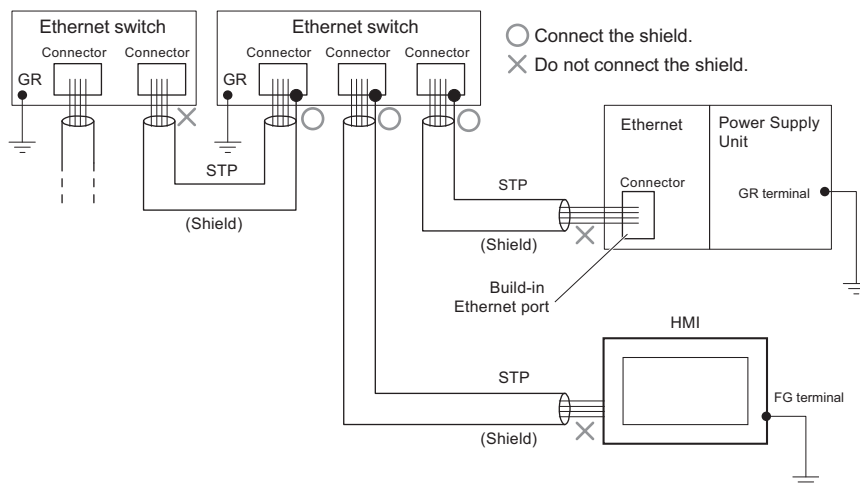

- Press the cable connector in firmly until it locks into place at both the Ethernet switch and the Ethernet port on the NA Unit.
- Lay and wire the twisted-pair cable separately from high-voltage lines.
- Do not install the network or network devices near devices that generate noise.
- Do not install the network or network devices in locations subject to high temperatures or high humidity.
- Do not install the network or network devices in locations subject to excessive dirt and dust or to oil mist or other contaminants.

2-2-3 Ethernet Switch Installation Environment Precautions

- Do not ground the Ethernet switch in the same location as a drive system component, such as an inverter.
- Always use a dedicated power supply for the Ethernet switch's power supply. Do not use the same power supply for other equipment, such as an I/O power supply, motor power supply, or control power supply.

- Before installation, check the Ethernet switch's environmental resistance specifications, and use an Ethernet switch that is appropriate for the ambient conditions. Contact the Ethernet switch manufacturer for details on Ethernet switch's environmental resistance specifications.

2-2-4 Ethernet Switch Connection Methods

- Connect two Ethernet switches to each other as follows: Connect an MDI port to an MDI-X port with a straight cable. Connect two MDI ports or two MDI-X ports with a cross cable.

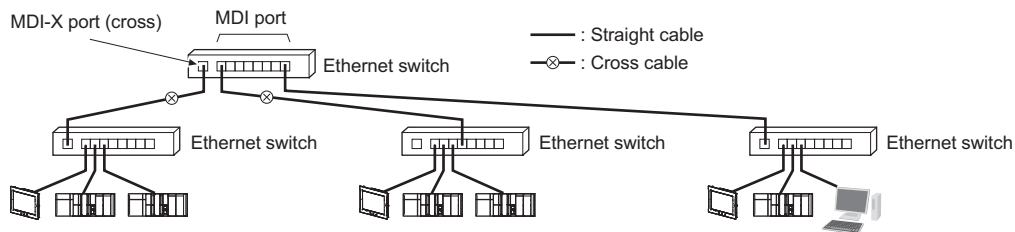

- Some Ethernet switches can automatically distinguish between MDI and MDI-X. When this kind of Ethernet switch is used, straight cable can be used between Ethernet switches.

3

Connecting an OMRON NJ-series Controller

This section provides details on connecting an OMRON NJ-series Controller via Ethernet.

3-1	Connecting via Ethernet	3-2
3-1-1	NJ-series Controller Settings	3-2
3-1-2	HMI Settings	3-3

3-1 Connecting via Ethernet

You can connect an NA-series Programmable Terminal to an NJ-series Controller via Ethernet.

You make the settings for the NJ-series Controller and HMI with the Sysmac Studio.



Precautions for Correct Use

- You must connect to the built-in EtherNet/IP port on an NJ-series CPU Unit. You cannot connect to Ethernet ports on EtherNet/IP Units.
- NJ-series Controller version 1.01 or later is required.

3-1-1 NJ-series Controller Settings

When you connect the HMI to an NJ-series Controller, you can make all of the settings with the Sysmac Studio.

Making Settings with the Sysmac Studio

You need to set the following items in the **Built-in EtherNet/IP Port Settings** under **Configurations and Setup – Controller Setup** in the Multiview Explorer of the Sysmac Studio.

- TCP/IP Settings Display

Open the TCP/IP Settings Display. You must set the IP address of the NJ-series built-in EtherNet/IP port to connect the HMI. Other items are set as required.

IP Address Settings

Item	Setting for the NJ-series Controller
IP address setting method	Sets the method to use to set the IP address of the built-in EtherNet/IP port. Use the default setting method (fixed setting) for the IP address.
IP address	Sets the IP address of the built-in EtherNet/IP port. Set the required IP address.
Subnet mask	Sets the subnet mask of the built-in EtherNet/IP port. Set it according to the network configuration.
Default gateway	Sets the default gateway IP address of the built-in EtherNet/IP. Set it according to the network configuration.

- LINK Settings Display

Item	Setting for the NJ-series Controller
LINK settings	Sets the baud rate of the built-in Ethernet/IP port. The default setting (Auto) is recommended.

3-1-2 HMI Settings

The following settings must be made for the HMI with the Sysmac Studio.

- Communications settings in the HMI Settings
- Registering the NJ-series Controller as a connected device in the Device References

Communications Settings

- 1 Double-click **HMI Settings** under **Configurations and Setup** in the Multiview Explorer.

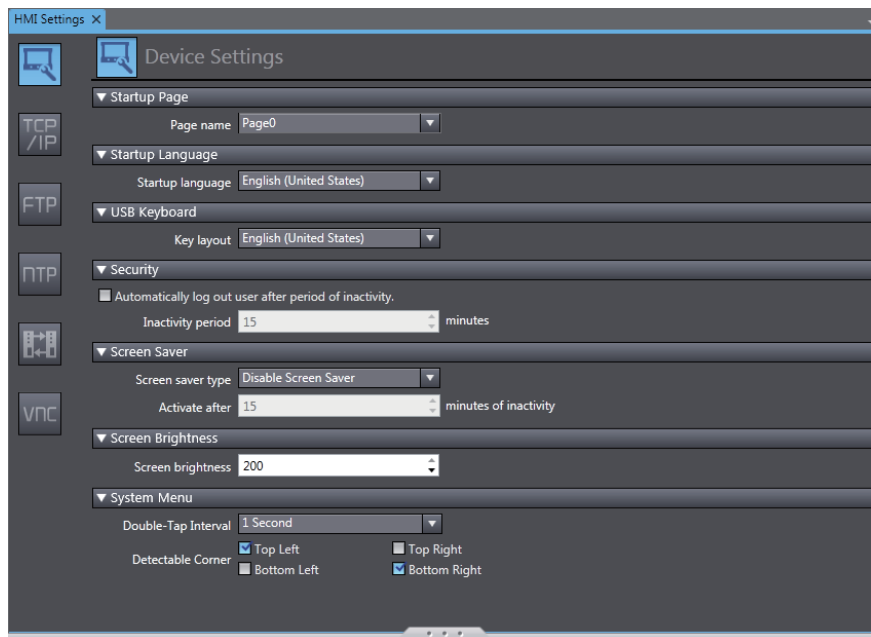

- 2 Click the **TCP/IP Settings** Button and set the IP address for Ethernet port 1 in the TCP/IP Settings. Also set the subnet mask and default gateway as required.

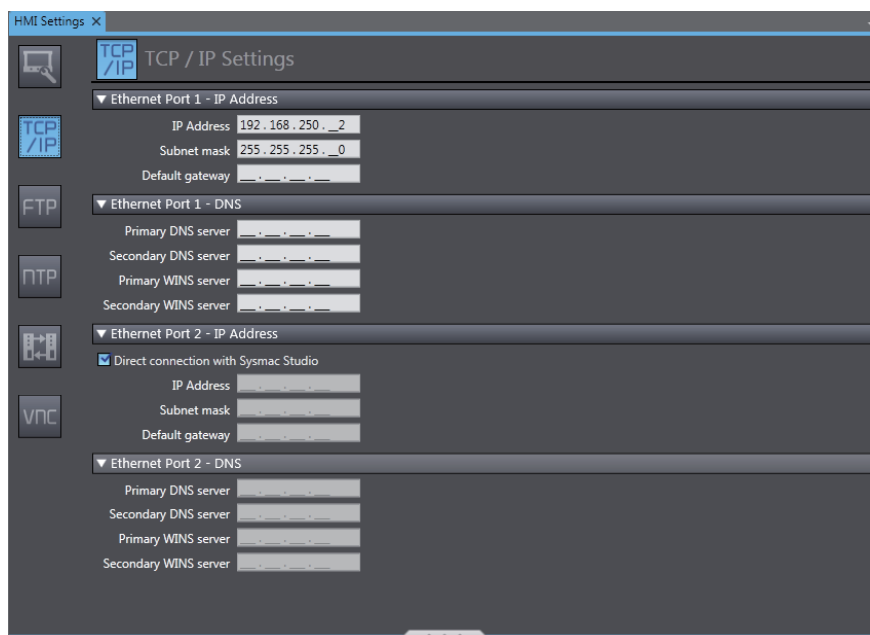

Registering the NJ-series Controller as a Connected Device in the Device References

Different registration methods are used to connect to a Controller that is registered in the current project and to connect to a Controller that is not registered in the current project.

- **Connecting an NJ-series Controller Registered in the Current Project:**

Registration is not necessary. The Controller is registered automatically in the Device References.

- **Connecting an NJ-series Controller Not Registered in the Current Project:**

- 1 Right-click **Device References** under **Configurations and Setup** in the Multiview Explorer and add an external connected device.

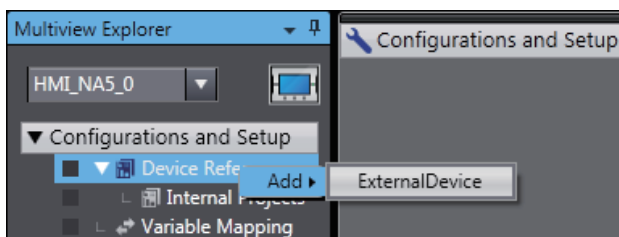

- 2 Double-click the added external connected device.

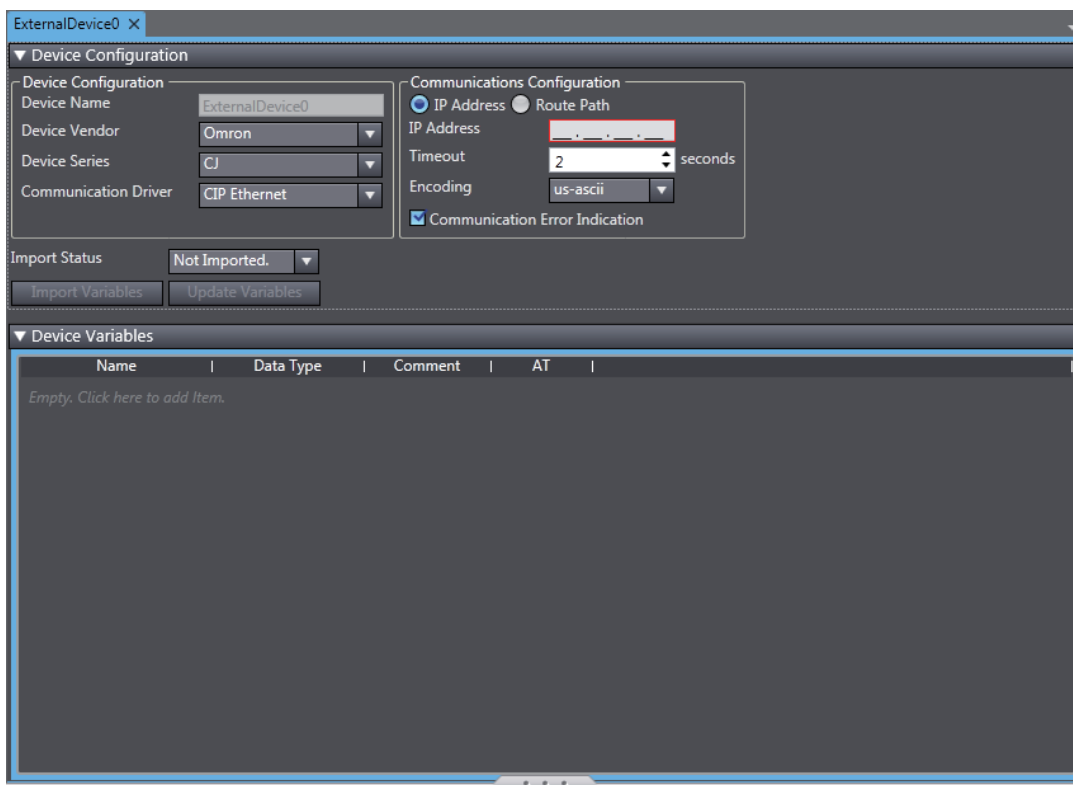

3 Make the following settings for the external connected device.

Device Configuration

- Device Vendor: Select “OMRON.”
- Device Series: Select “NJ.”
- Communication Driver: Select “Ethernet.”

Communication Configuration

- IP Address: Set the IP address of the connected device.
- Timeout: Set the time for timeouts during communications.
- Communication Error Indication: Clear the selection of the check box if you do not need to display an error dialog when a communications error occurs.

The screenshot shows the configuration window for 'ExternalDevice0'. It is divided into two main sections: 'Device Configuration' and 'Communications Configuration'. Below these are 'Import Status' and 'Device Variables'.

Device Configuration:

- Device Name: ExternalDevice0
- Device Vendor: Omron
- Device Series: NJ
- Communication Driver: Ethernet

Communications Configuration:

- IP Address: 192.168.250.1
- Timeout: 2 seconds
- Communication Error Indication

Import Status: Not Imported.

Device Variables: A table with columns for Name, Data Type, Comment, and AT. The table is currently empty, with a message: "Empty. Click here to add item."

Registering Device Variables

There are two methods to register device variables.



Precautions for Correct Use

You cannot copy and paste a structure variable from the global variable table of another project. If you need to register a structure variable, import it from the NJ-series Controller.

● Importing Device Variables from an NJ-series Controller

Use the following procedure to connect to an NJ-series Controller and import variables from it.

- 1 Enable connecting the Controller to the Sysmac Studio in the network configuration that was set in the communications settings.
- 2 Click the **Import Variables** Button.

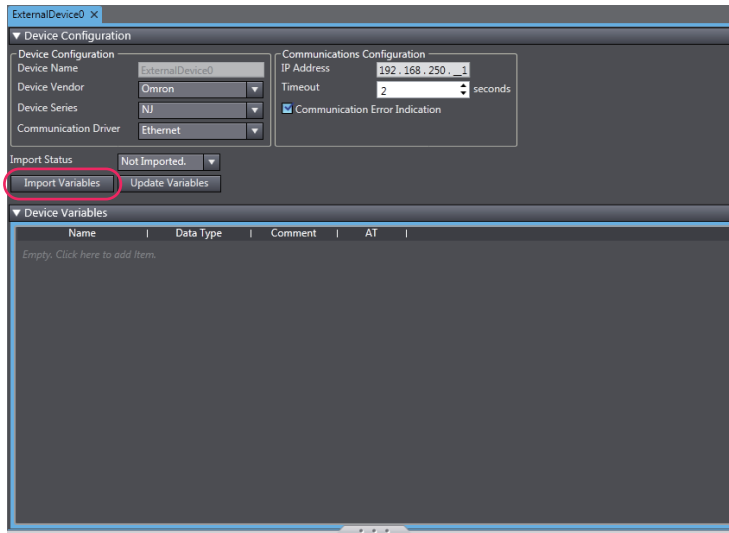

- 3 The global variables are transferred from the Controller and registered as device variables.

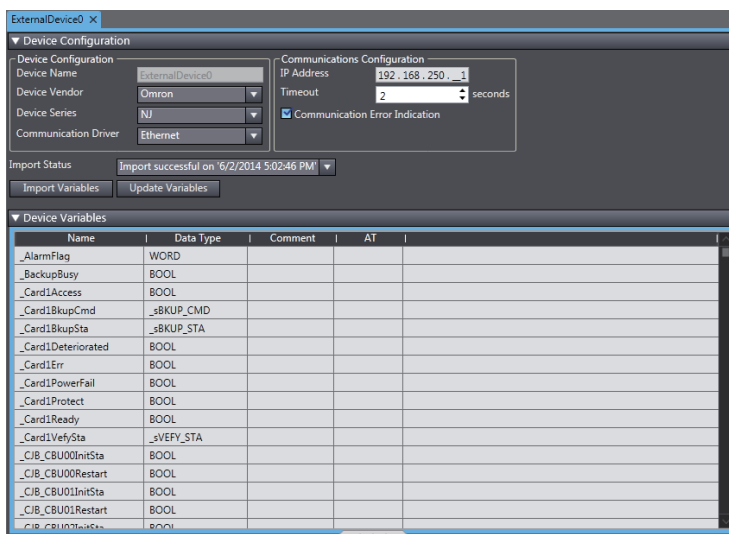

● Copying Variables from the Global Variable Table of Another Project

Use the following procedure to copy variables from the global variable table of another project.

- 1 Open a project in which a Controller is registered as an external connected device. Open the global variable table and copy the required variables.

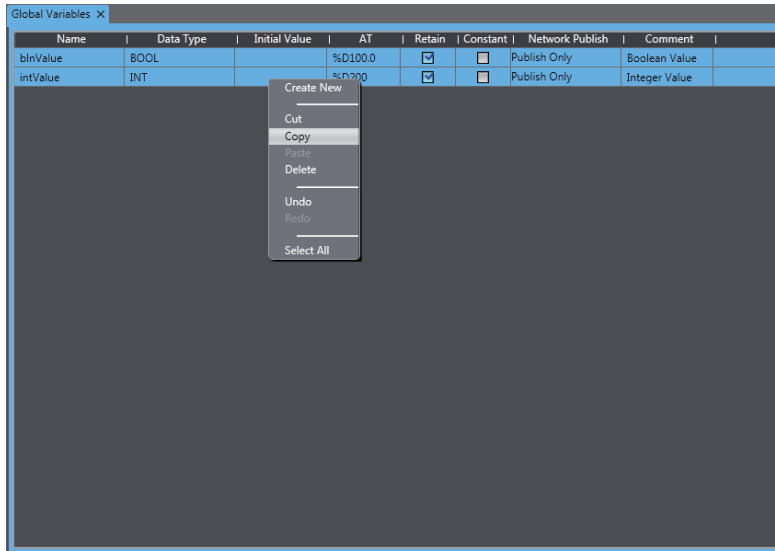

- 2 Paste the device variables in a spreadsheet, delete unnecessary rows, and sort and copy the remaining rows. Refer to *A-1 Clipboard Format for Device Variable Table Data* on page A-2 for information on the order of the rows.

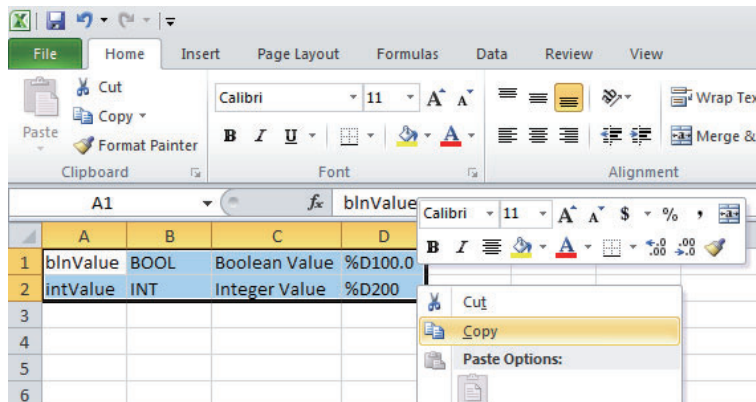

- 3 Paste the variables in the device variable table of the HMI project.

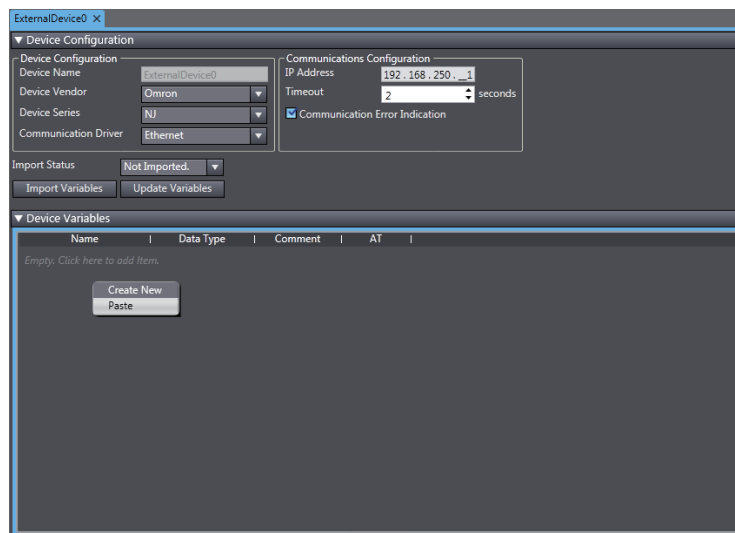

Mapping Variables

Conform the following specifications when you assign the variables of the NJ-series Controller to the global variables.

● Supported Data Types

You can assign the following NJ-series data types to the global variables.

BOOL, BYTE, WORD, DWORD, LWORD, SINT, INT, DINT, LINT, USINT, UINT, UDINT, ULINT, REAL, LREAL, TIME, DATETIME_OF_DAY, DATE_AND_TIME, and STRING

You can also access array and structure members that have any of the above data types. The minimum value of the subscript of an array is always 0. The maximum value of the subscript is the maximum value for the array registered in the NJ-series Controller.

● Data Types Supported by the NJ-series Controllers and the HMIs

The following table shows the corresponding data types of the NJ-series Controllers and the HMIs.

NJ-series data type	HMI data type
BOOL	Boolean
INT	Short
DINT	Integer
LINT	Long
UINT	UShort
WORD	
UDINT	UInteger
DWORD	
ULINT	Ulong
LWORD	
REAL	Single
LREAL	Double
STRING	String
SINT	SByte
USINT	Byte
BYTE	
TIME	TimeSpan
DATE	Date
DATE_AND_TIME	
TIME_OF_DAY	

4

Connecting to an OMRON CJ-series PLC

This section describes connection methods for an OMRON CJ-series PLC.

4-1	Connecting via Ethernet (FINS)	4-2
4-1-1	Making Settings for the CJ-series PLC	4-2
4-1-2	Settings for the HMI	4-5
4-2	Connecting via EtherNet/IP	4-12
4-2-1	EtherNet/IP	4-12
4-2-2	Settings for the CJ-series PLC	4-12
4-2-3	Settings for the HMI	4-14

4-1 Connecting via Ethernet (FINS)

You can connect an NA-series Programmable Terminal to a CJ-series PLC using Ethernet (FINS).

Make the settings for the CJ-series PLC from the CX-Programmer.

Make the settings for the HMI from the Sysmac Studio.

4-1-1 Making Settings for the CJ-series PLC

The Unit used for Ethernet communications depends on the model of the OMRON PLC that you use.

When connecting through Ethernet, check the model of the PLC at the destination and the Unit mounted to the PLC.

For details on Units that can be connected to the NA-series Programmable Terminals via the Ethernet, refer to *Section 1 Supported Devices*.

Setting the Front Panel Switches

Set the unit number and FINS node address with the front panel switches.



Precautions for Safe Use

- Always turn OFF the power to the PLC before setting the rotary switches.
- Create I/O tables for the CPU Unit when setting the unit number for the first time or when changing the settings.

CJ-series CPU Units (built-in EtherNet/IP port):

CJ2H-CPU□□-EIP

CJ2M-CPU3□

CJ-series EtherNet/IP Unit:

CJ1W-EIP21

CJ-series Ethernet Unit:

CJ1W-ETN21

● Setting the Unit Number

Always set unique unit numbers for all of the CPU Bus Units mounted to the same CPU Unit. Use a small screwdriver to set the rotary switch. Be careful not to damage it. The switch is set to 0 at the factory.



Setting range

0 to F

● Setting the Node Number

Use the node number switches to set the node number to a unique hexadecimal value. Do not set it to the same value as any other Ethernet Unit or built-in port on the same Ethernet network. As long as it does not use the same number as another Ethernet Unit or built-in port, the node address can be set from 01 to 7E in hex (1 to 126 in decimal).

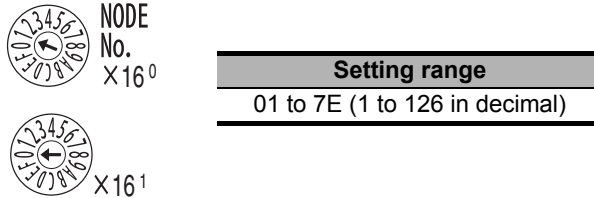

Set the upper digit using the top rotary switch and the lower digit using the bottom rotary switch. The switches are set to 01 at the factory. Automatic generation must be selected as the address conversion method when connecting to an HMI. Therefore, set the rightmost byte of the local IP address to the same value as that of the node number.

Making Settings with the CX-Programmer

Make the Unit settings and register the variables.

● Unit Settings

The following items must be set in the Unit Settings of the CX-Programmer.

TCP/IP Tab Page

Item	Settings
IP address	Sets the IP address of the Ethernet port. Set the required IP address.
Subnet mask	Sets the subnet mask of the Ethernet port. Make the setting according to the network configuration.
Default gateway	Sets the default gateway of the Ethernet port. Make the setting according to the network configuration.

Ethernet Tab Page

Item	Settings
LINK setting	Sets the baud rate. Using the default value (Auto) is recommended.

FINS/UDP Tab Page

Item	Settings
FINS/UDP Port No.	Sets the local UDP port number that is used for the FINS communications service. Use the default setting (9600).
IP address conversion	Set one of the following methods of the address conversion to obtain the IP address from the FINS node address. <ul style="list-style-type: none"> • Automatic generation, dynamic • Automatic generation, static
IP address table	The IP address table indicates the relation between FINS node addresses and IP addresses. The IP address table is not used for the HMI. Automatic generation must be used.
Dynamically change remote IP	Sets whether to dynamically change remote IP addresses for FINS/UDP. Clear the selection of the check box. Dynamically changing remote IP addresses must be disabled.

Set the routing tables on the CX-Integrator as required.

For details on setting routing tables, refer to the *CX-Integrator Ver. 2. □ Operation Manual* (Cat. No. W464).

● Registering Variables

Register variables as global variables on the CX-Programmer.

- Set the addresses of the registered variables manually or automatically.

4-1-2 Settings for the HMI

The following settings must be made for the HMI with the Sysmac Studio.

- Communications Settings in the HMI Settings
- Registering the CJ-series PLC as a connected device in the Device References

Communications Settings

- 1 Double-click **HMI Settings** under **Configurations and Setup** in the Multiview Explorer.

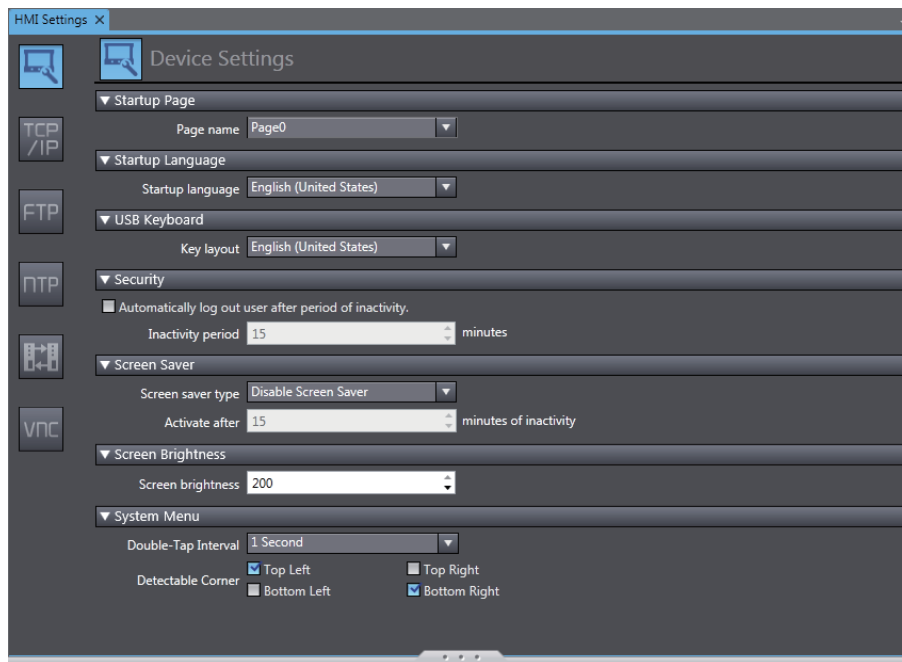

- 2 Click the **TCP/IP Settings** Button and set the IP address and other settings for Ethernet port 1 on the TCP/IP Settings Display. Also set the subnet mask and default gateway as required.

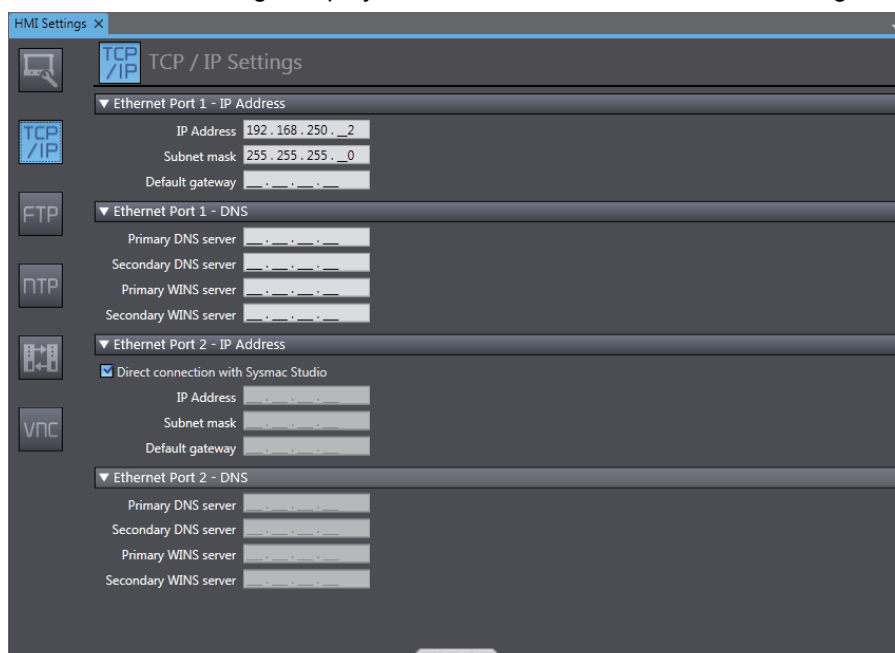

- 3** Click the **FINS Settings** Button and set the network address for Ethernet port 1. Set the routing table as required.

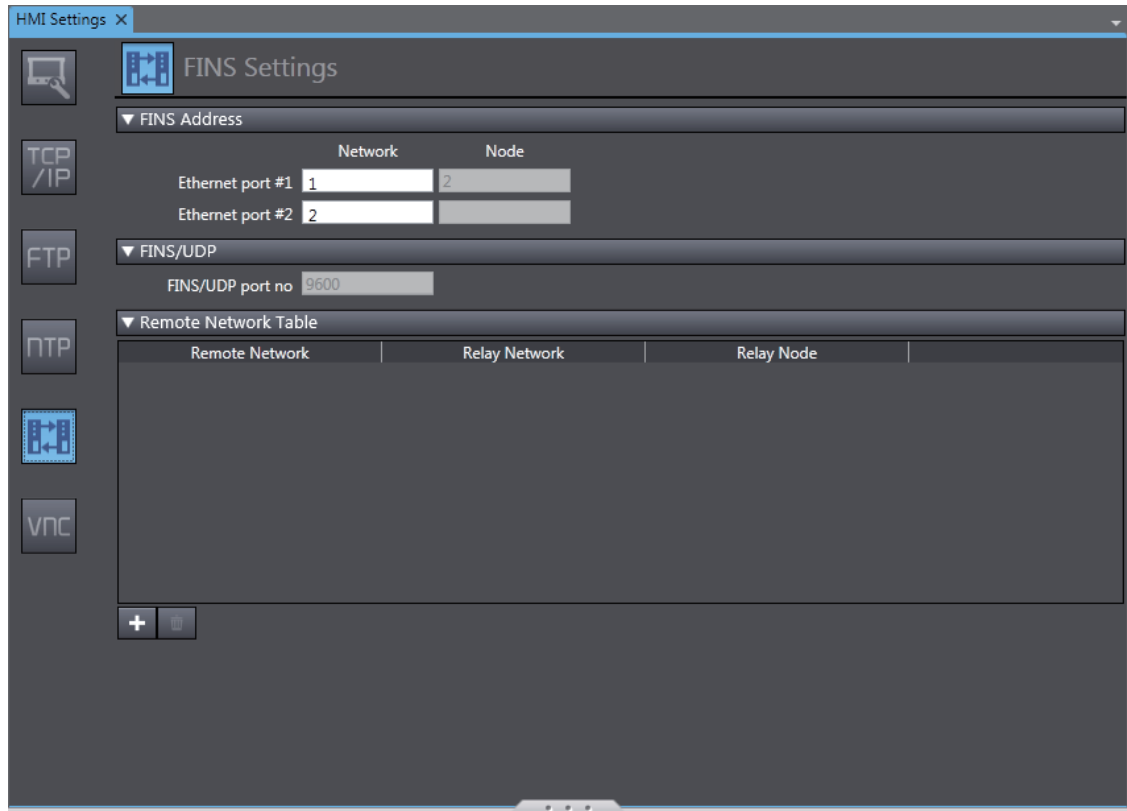

Additional Information

Node addresses are generated automatically from the IP addresses. The node address is the same as the lowest digit of the IP address.

Registering the CJ-series PLC as a Connected Device in the Device References

- 1 Right-click **Device References** under **Configurations and Setup** in the Multiview Explorer and add an external connected device.

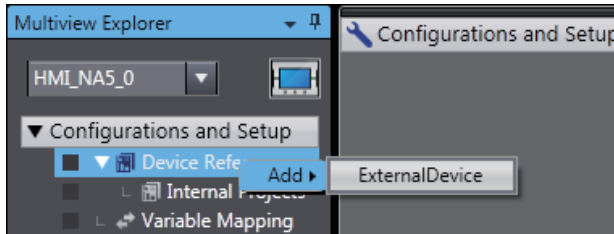

- 2 Double-click the added external connected device.

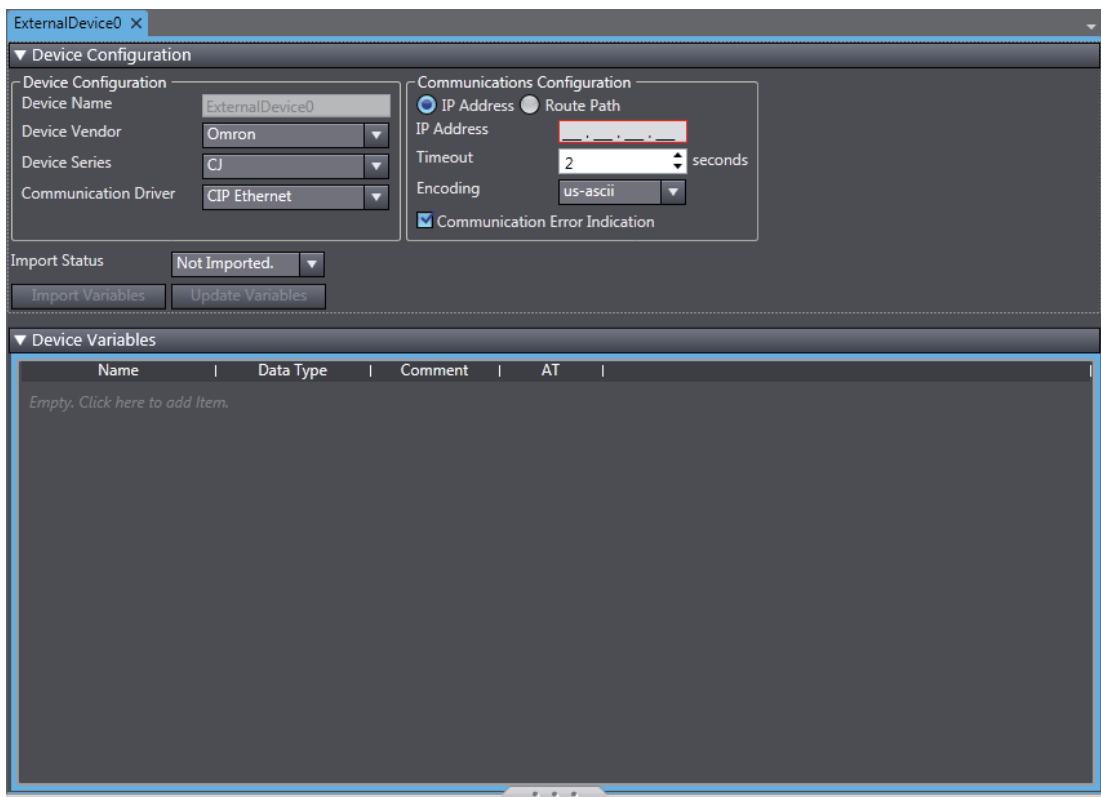

3 Make the following settings for the external connected device.

Device Configuration

- Device Vendor: Select “OMRON.”
- Device Series: Select “CJ.”
- Communication Driver: Select “FINS Ethernet.”

Communication Configuration

- Network Address: Set the network address for FINS.
- Node Address: Set the node address for FINS.
- Frame Length: Set the frame length for FINS.
- Timeout: Set the time for timeouts during communications.
- Encoding: Select the encoding for character strings on the connected device.
- Communication Error Indication: Clear the selection of the check box if you do not need to display an error dialog when a communications error occurs.

The screenshot shows a software window titled "ExternalDevice0" with a close button. It is divided into several sections:

- Device Configuration:** Contains four dropdown menus: "Device Name" (ExternalDevice0), "Device Vendor" (Omron), "Device Series" (CJ), and "Communication Driver" (FINS Ethernet).
- Communications Configuration:** Contains five input fields: "Network Address" (1), "Node Address" (1), "Frame Length" (2000 bytes), "Timeout" (2 seconds), and "Encoding" (us-ascii). There is also a checked checkbox for "Communication Error Indication".
- Import Status:** A dropdown menu set to "Not Imported".
- Buttons:** "Import Variables" and "Update Variables".
- Device Variables:** A table with columns "Name", "Data Type", "Comment", and "AT". The table is currently empty, with a note "Empty. Click here to add Item."

Registering Device Variables

Use the following procedure to import device variables.

- 1 Select the necessary global variables with the CX-Programmer and copy them.

Name	Data Type	Address / Value	Net. Variable	Rack Location	Usage	Comment
blnValue	BOOL	D100.00			Work	Boolean Value
intValue	INT	D200			Work	Integer value
P_0_01s	BOOL	CF105			Work	0.01 second clock pulse
P_0_02s	BOOL	CF103			Work	0.02 second clock pulse
P_0_1ms	BOOL	CF107			Work	0.1 millisecond clock pulse
P_0_1s	BOOL	CF100			Work	0.1 second clock pulse
P_0_2s	BOOL	CF101			Work	0.2 second clock pulse
P_1min	BOOL	CF104			Work	1 minute clock pulse bit
P_1ms	BOOL	CF106			Work	1 millisecond clock pulse
P_1s	BOOL	CF102			Work	1.0 second clock pulse bit
P_AER	BOOL	CF011			Work	Access Error Flag
P_CIO	WORD	A450			Work	CIO Area Parameter
P_CY	BOOL	CF004			Work	Carry (CY) Flag
P_Cycle_Time_Error	BOOL	A401.08			Work	Cycle Time Error Flag
P_Cycle_Time_Value	UDINT	A264			Work	Present Scan Time
P_DM	WORD	A460			Work	DM Area Parameter
P_EM0	WORD	A461			Work	EM0 Area Parameter
P_EM1	WORD	A462			Work	EM1 Area Parameter
P_EM2	WORD	A463			Work	EM2 Area Parameter
P_EM3	WORD	A464			Work	EM3 Area Parameter
P_EM4	WORD	A465			Work	EM4 Area Parameter
P_EM5	WORD	A466			Work	EM5 Area Parameter

- 2 Paste the device variables in a spreadsheet, delete unnecessary rows, and sort and copy the remaining rows. Refer to A-1 *Clipboard Format for Device Variable Table Data* on page A-2 for information on the order of the rows.

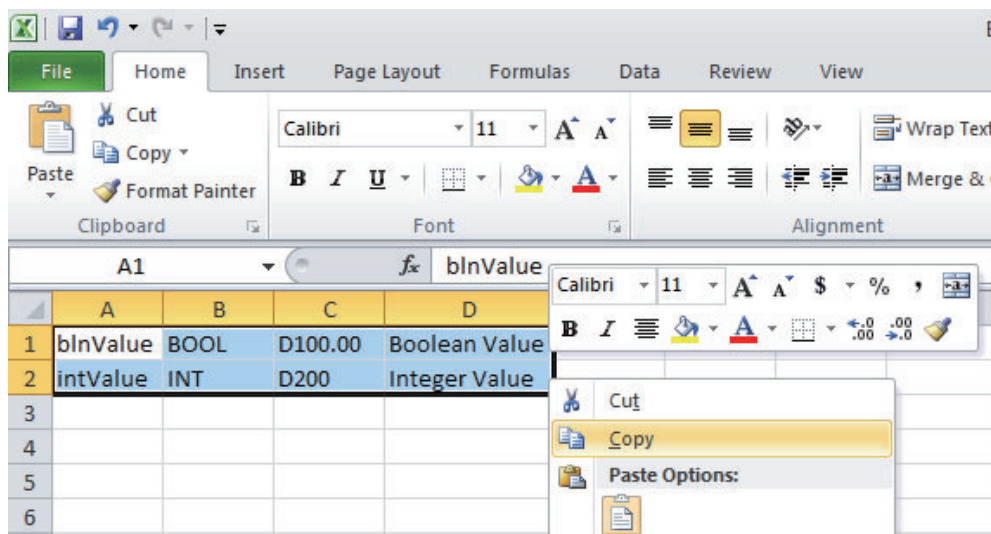

3 Paste the variables in the device variable table of the HMI project.

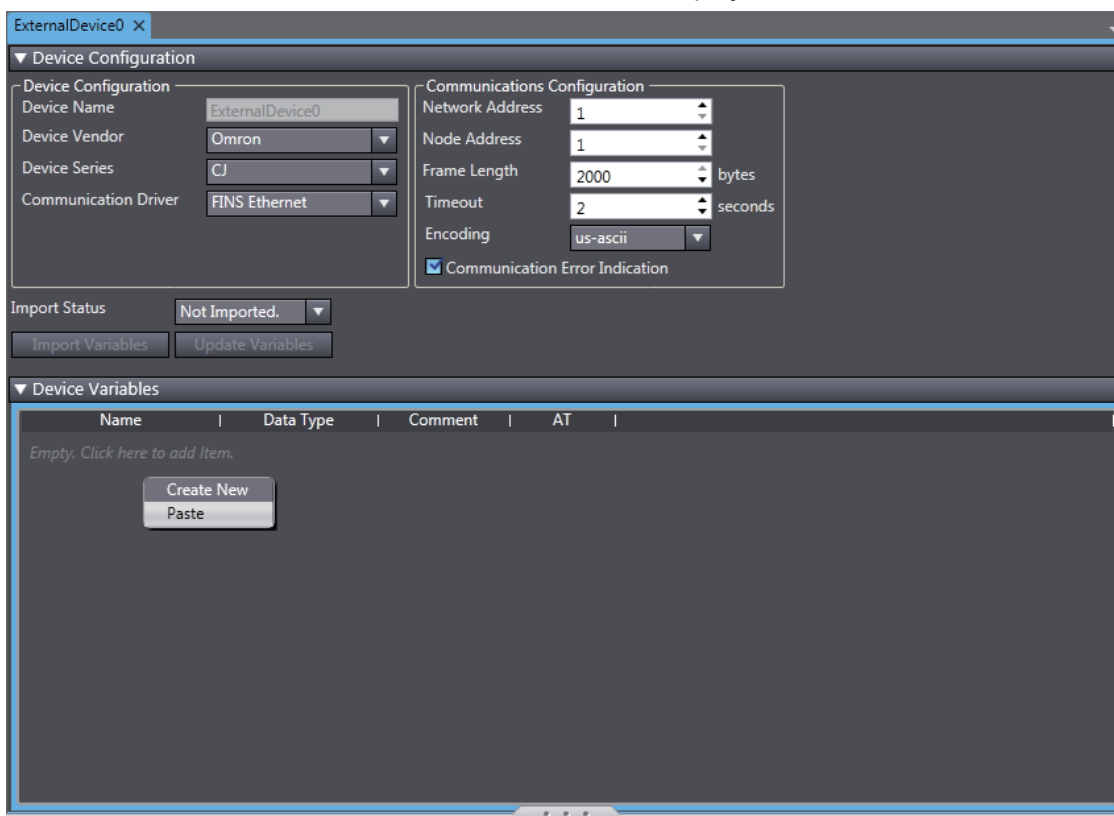

Mapping Variables

Conform the following specifications when you assign variables of the CJ-series PLC to the global variables.

● **Range of Accessible Addresses**

The following table gives the ranges of addresses that you can assign. The upper limits, area ranges, and attributes of the addresses depend on the model. For details, refer to the manual for your PLC.

Area name	Description of area	Range	Word access		Bit access		Restrictions and remarks
			Read	Write	Read	Write	
CIO	I/O Area	00000 to 06143	Yes	Yes	Yes	Yes	
HR	Holding Area	00000 to 00511	Yes	Yes	Yes	Yes	
AR	Auxiliary Area	00000 to 01471 10000 to 11535	Yes	Conditional	Yes	Conditional	
T	Timer PVs	00000 to 04095	Yes	Yes	No	No	
C	Counter PVs	00000 to 04095	Yes	Yes	No	No	
DM	DM Area	00000 to 32767	Yes	Yes	Yes	Yes	
EM	EM Area (current bank)	00000 to 32767	Yes	Yes	Yes*1	Yes*1	
EM0 to EM18	EM Area	00000 to 32767	Yes	Yes	Yes*1	Yes*1	
WR	Work Area	00000 to 00511	Yes	Yes	Yes	Yes	
TU	Time Completion Flags	00000 to 04095	No	No	Yes	No	
CU	Counter Completion Flags	00000 to 04095	No	No	Yes	No	

*1. Supported only for CJ2 PLCs.

● Supported Data Types

You can assign the following CJ-series data types to global variables.

BOOL, INT, DINT, LINT, UINT, WORD, UINT_BCD, UDINT, DWORD, UDINT_BCD, ULINT, LWORD, ULINT_BCD, REAL, LREAL, and STRING

You can also access array members that have the supported data types.

● Data Types Supported by the CJ-series PLCs and the HMIs

The following table shows the corresponding data types of the CJ-series PLCs and the HMIs.

CJ-series data type	HMI data type
BOOL	Boolean
INT	Short
DINT	Integer
LINT	Long
UINT	UShort
WORD	
UINT_BCD	
UDINT	UInteger
DWORD	
UDINT_BCD	
ULINT	Ulong
LWORD	
ULINT_BCD	
REAL	Single
LREAL	Double
STRING	String

4-2 Connecting via EtherNet/IP

You can connect an NA-series Programmable Terminal to a CJ-series PLC using EtherNet/IP.

Make the settings for the CJ-series PLC with the CX-Programmer.

Make the settings for the HMI with the Sysmac Studio.

4-2-1 EtherNet/IP

EtherNet/IP is a multi-vendor industrial network protocol that uses Ethernet. It is an open standard managed by the ODVA (Open DeviceNet Vendor Association) and is used for a variety of industrial devices.

It is possible to perform tag message communications when using a CPU Unit with a built-in EtherNet/IP port. The CPU Units with built-in EtherNet/IP ports contain a tag name server, so if tag names and an address table are stored in advance in the CPU Unit, it is possible to perform access from the HMI using only the tag names.

The NA-series Programmable Terminal can communicate with a CJ-series EtherNet/IP Unit or CPU Unit with a built-in EtherNet/IP port using the tag names. However, communications using addresses is not supported.

4-2-2 Settings for the CJ-series PLC

When connecting through EtherNet/IP, check the model of the PLC at the destination and the Unit mounted to the PLC.

Refer to *Section 1 Supported Devices* for the PLC models and Units that you can connect to the NA-series Programmable Terminal.

Setting the Front Panel Switch

Set the unit number with the front panel switch.



Precautions for Safe Use

- Always turn OFF the power to the PLC before setting the rotary switch.
- Create I/O tables for the CPU Unit when setting the unit number for the first time or when changing the settings.

CJ-series CPU Units (built-in EtherNet/IP port):

CJ2H-CPU□□-EIP

CJ2M-CPU3□

CJ-series EtherNet/IP Unit:

CJ1W-EIP21

● Setting the Unit Number

Always set unique unit numbers for all of the CPU Bus Units mounted to the same CPU Unit. Be careful not to damage it. The switch is set to 0 at the factory.



Setting range
0 to F

Making Settings with CX-Programmer

Make the Unit settings and register the variables.

● Unit Settings

The following items must be set in the Unit Settings of the CX-Programmer.

TCP/IP Tab Page

Item	Setting for the CJ series PLC
IP address	Sets the IP address of the EtherNet/IP port.
Subnet mask	Sets the subnet mask of the EtherNet/IP port. Make the setting according to the network configuration.
Default gateway	Sets the IP address of the default gateway of the EtherNet/IP port. Make the setting according to the network configuration.

Ethernet Tab Page

Item	Setting for the CJ series PLC
LINK setting	Sets the baud rate. Using the default value (Auto) is recommended.

● Registering Variables

Register global variables with the CX-Programmer.

- Set the addresses of the registered variables manually or automatically.
- Variables must be registered as network variables to use CIP message communications with tags. When you register the variables, select the *Network Variable* and *Open Only* Check Boxes.

Note Select either *Input* or *Output*. (It does not matter which one you select.)

4-2-3 Settings for the HMI

The following settings must be made for the HMI with the Sysmac Studio.

- Communications settings in the HMI Settings
- Registering the CJ-series PLC as a connected device in the Device References

Communications Settings

- 1 Double-click **HMI Settings** under **Configurations and Setup** in the Multiview Explorer.

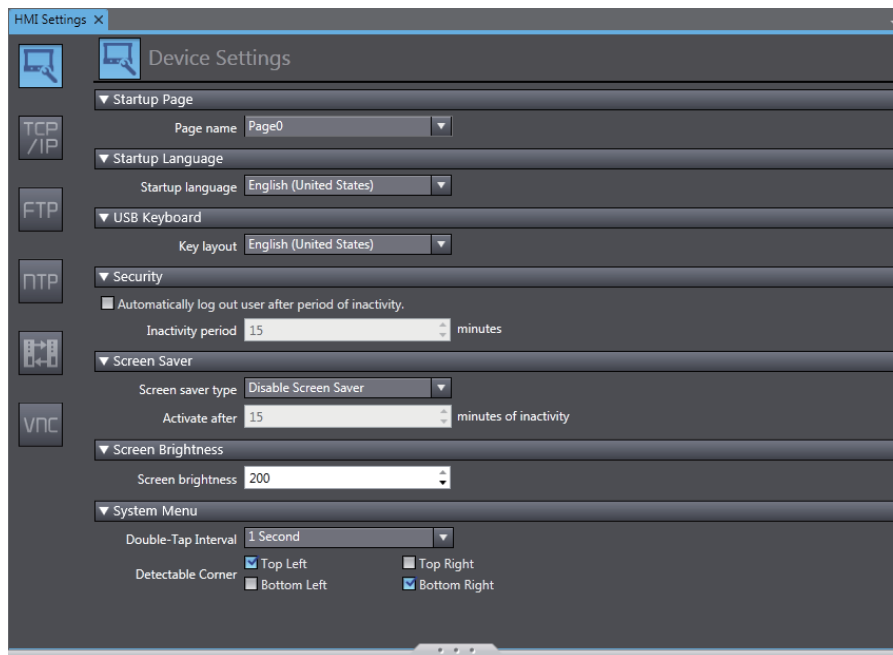

- 2 Click the **TCP/IP Settings** Button and set the IP address and other settings for Ethernet port 1 on the TCP/IP Settings Display. Also set the subnet mask and default gateway if necessary.

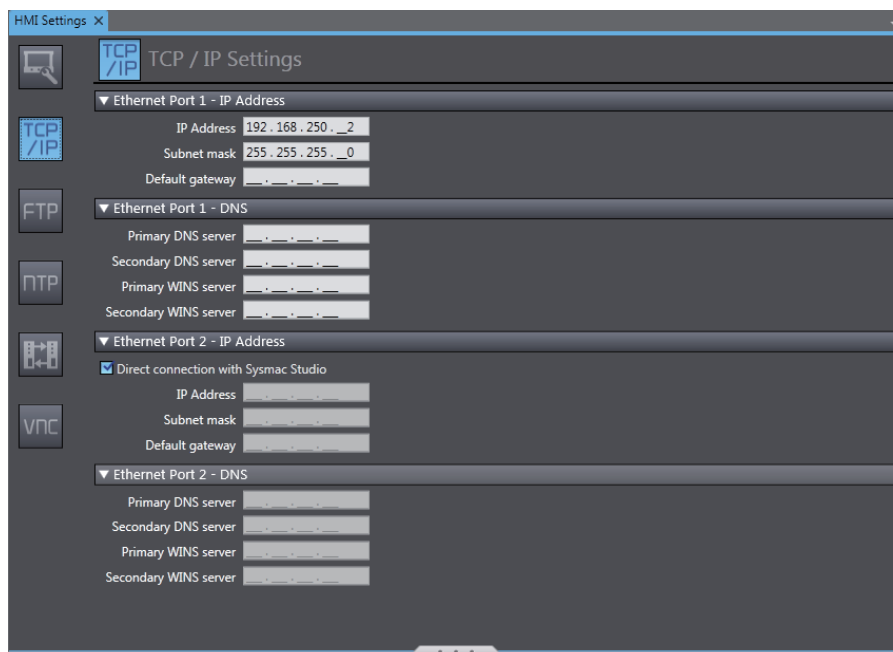

Registering the CJ-series PLC as a Connected Device in the Device References

- 1 Right-click **Device References** under **Configurations and Setup** in the Multiview Explorer and add an external connected device.

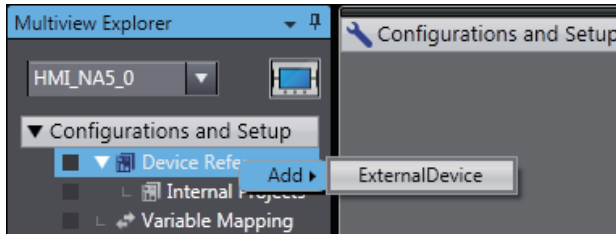

- 2 Double-click the added external connected device.

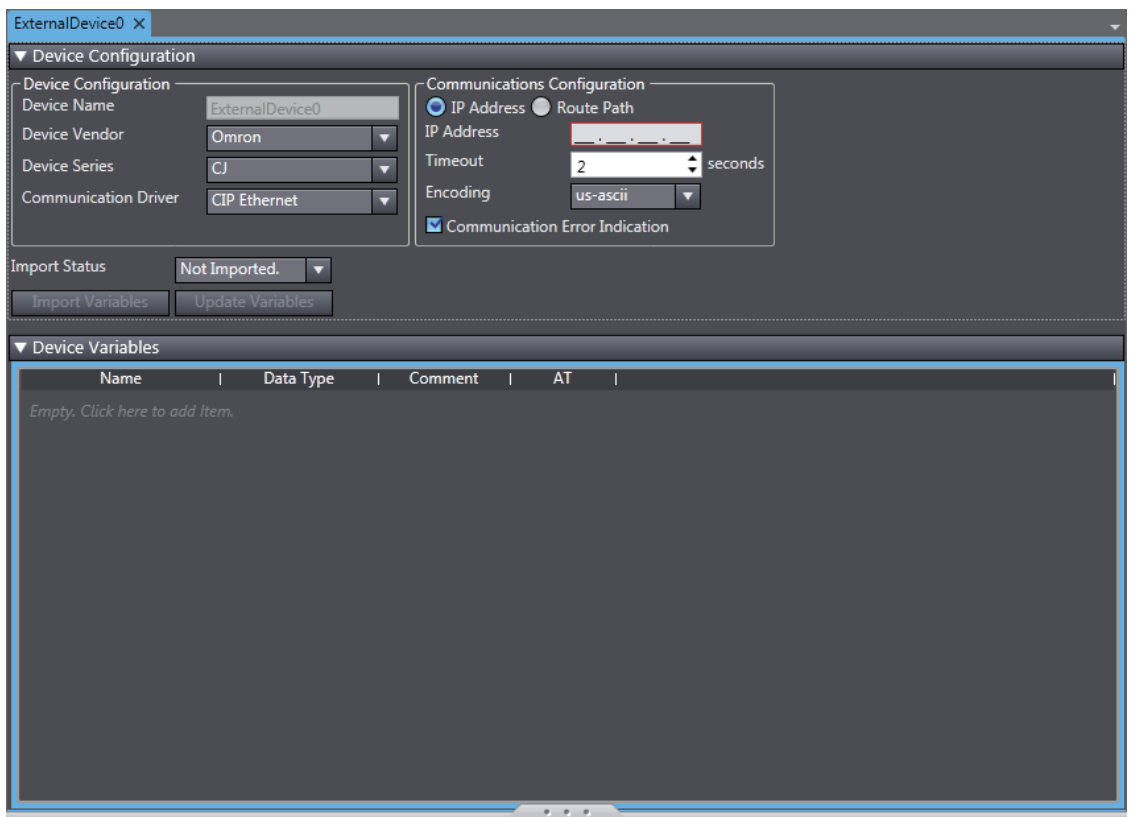

3 Make the following settings for the external connected device.

Device Configuration

- Device Vendor: Select “OMRON.”
- Device Series: Select “CJ.”
- Communication Driver: Select “CIP Ethernet.”

Communication Configuration

- IP Address/Routing Path: Select either an IP address or a route path and then set it.
- Timeout: Set the time for Timeouts during communications.
- Encoding: Select the encoding for character strings on the connected device.
- Communication Error Indication: Clear the selection of the check box if you do not need to display an error dialog when a communications error occurs.

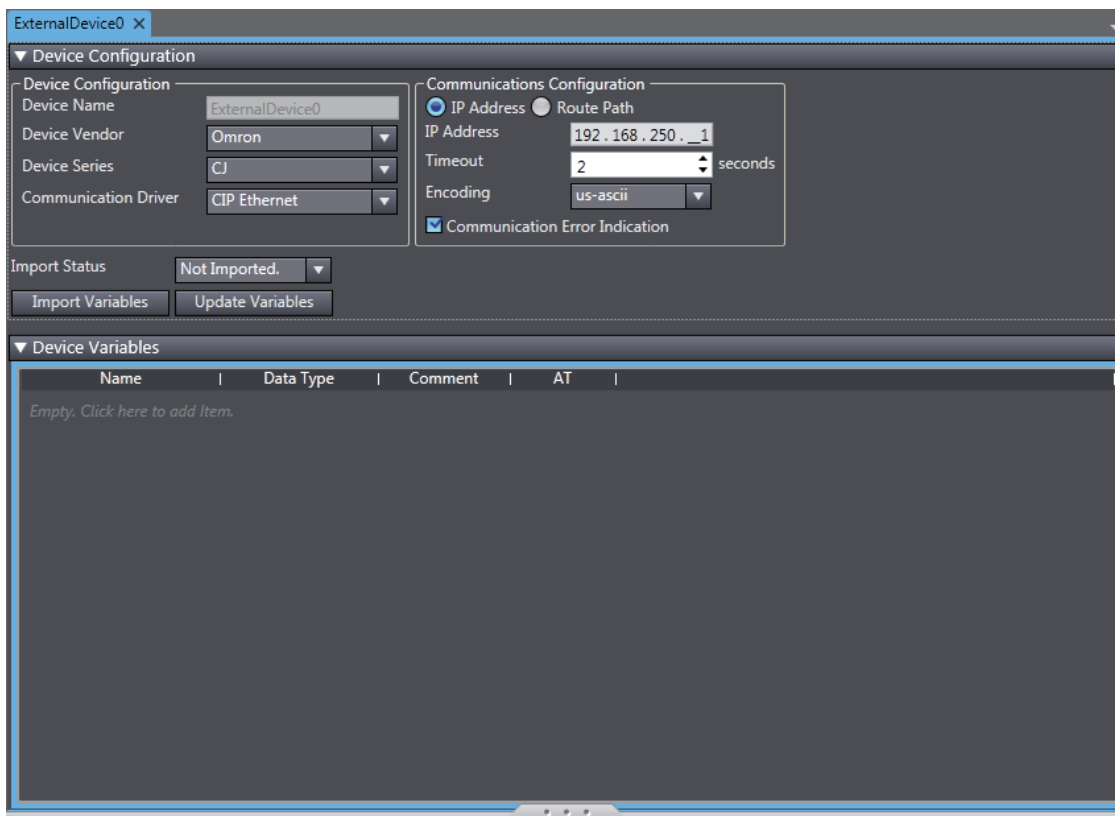

Registering Device Variables

There are two methods to register device variables.

● Importing Device Variables from the CJ-series PLC

- 1 Enable connecting to the CJ-series PLC for the network configuration that was set with the communications settings.
- 2 Click the **Import Variables** Button.

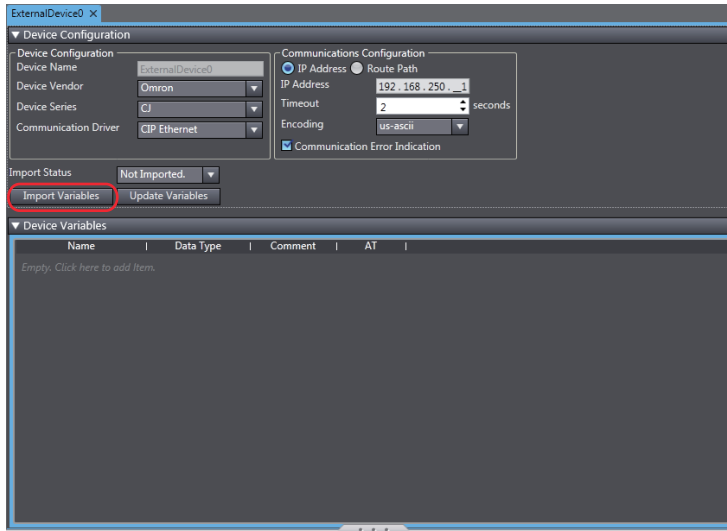

- 3 The global variables of the CJ-series PLC are transferred and registered as device variables.

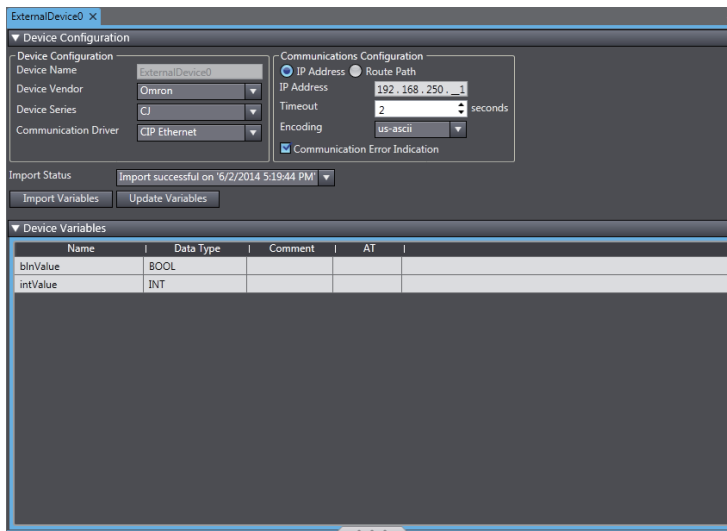

● Copying Device Variables with the CX-Programmer

1 Select the necessary global variables with the CX-Programmer and copy them.

Name	Data Type	Address / Value	Net. Variable	Rack Location	Usage	Comment
blnValue	BOOL	D100.00	Publication		Work	Boolean Value
intValue	INT	D200	Publication		Work	Integer value
· P_0_01s	BOOL	CF105			Work	0.01 second clock pulse
· P_0_02s	BOOL	CF103			Work	0.02 second clock pulse
· P_0_1ms	BOOL	CF107			Work	0.1 millisecond clock pulse
· P_0_1s	BOOL	CF100			Work	0.1 second clock pulse
· P_0_2s	BOOL	CF101			Work	0.2 second clock pulse
· P_1min	BOOL	CF104			Work	1 minute clock pulse bit
· P_1ms	BOOL	CF106			Work	1 millisecond clock pulse
· P_1s	BOOL	CF102			Work	1.0 second clock pulse
· P_AER	BOOL	CF011			Work	Access Error Flag
· P_CIO	WORD	A450			Work	CIO Area Parameter
· P_CY	BOOL	CF004			Work	Carry (CY) Flag
· P_Cycle_Time_Error	BOOL	A401.08			Work	Cycle Time Error Flag
· P_Cycle_Time_Value	UDINT	A264			Work	Present Scan Time
· P_DM	WORD	A460			Work	DM Area Parameter
· P_EM0	WORD	A461			Work	EM0 Area Parameter
· P_EM1	WORD	A462			Work	EM1 Area Parameter
· P_EM2	WORD	A463			Work	EM2 Area Parameter
· P_EM3	WORD	A464			Work	EM3 Area Parameter
· P_EM4	WORD	A465			Work	EM4 Area Parameter
· P_EM5	WORD	A466			Work	EM5 Area Parameter

2 Paste the device variables in a spreadsheet, delete unnecessary rows, and sort and copy the remaining rows. Refer to *A-1 Clipboard Format for Device Variable Table Data* on page A-2 for information on the order of the rows.

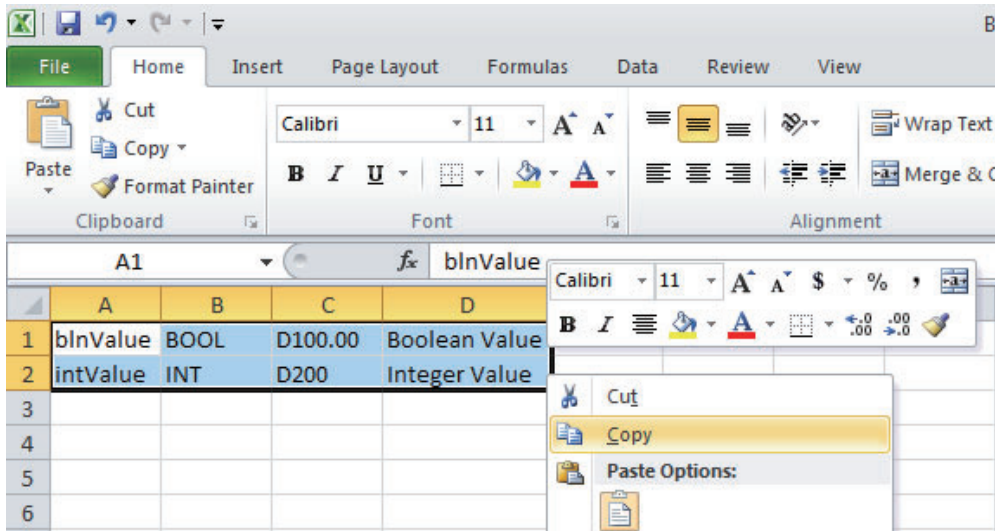

3 Paste the variables in the device variable table of the HMI project.

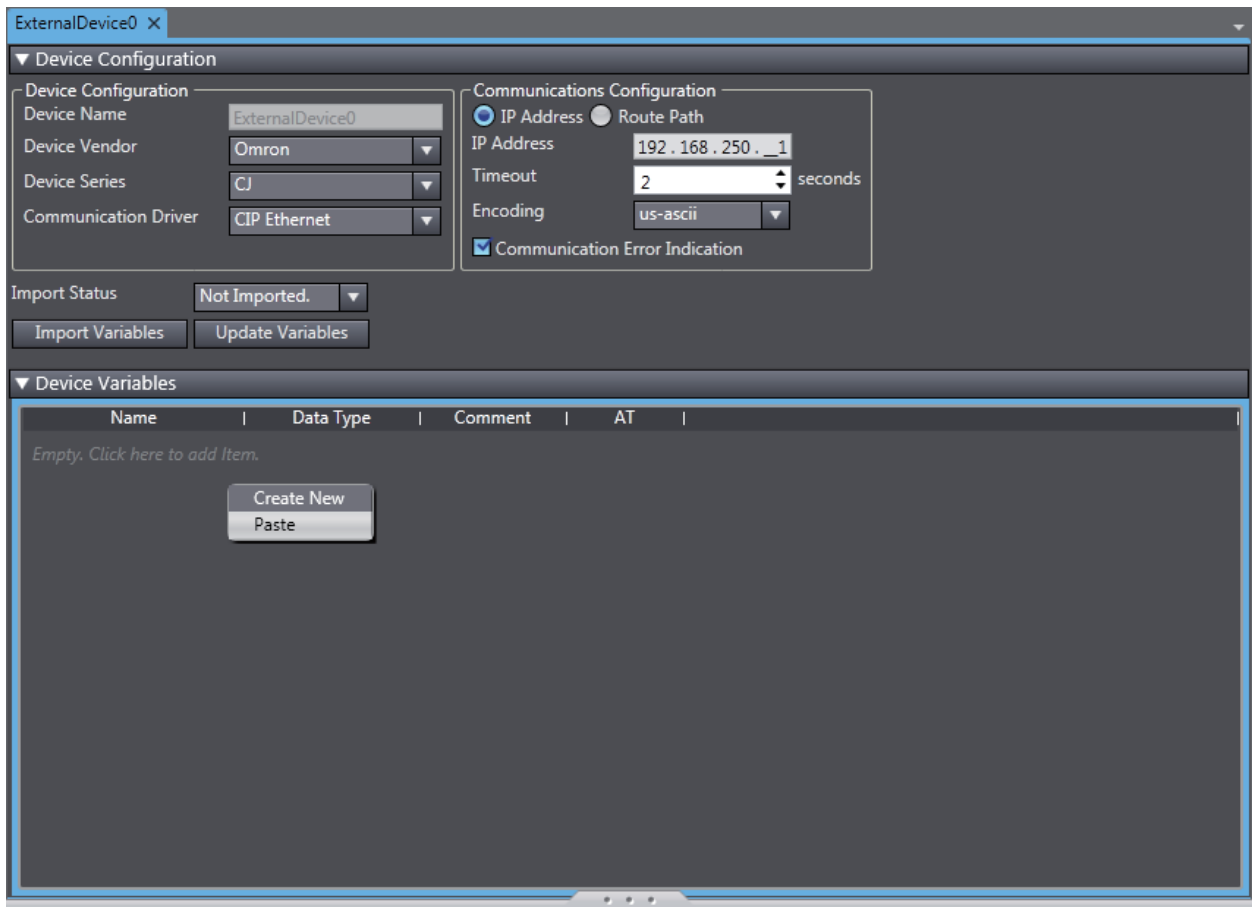

Mapping Variables

Conform the following specifications when you assign variables of the CJ-series PLC to the global variables.

● Supported Data Types

You can assign the following CJ-series data types to global variables.

BOOL, INT, DINT, LINT, UINT, WORD, UINT_BCD, UDINT, DWORD, UDINT_BCD, ULINT, LWORD, ULINT_BCD, REAL, LREAL, and STRING

You can also access array and structure members that have any of the above data types.

- **Data Types Supported by the CJ-series Controllers and the HMIs**

The following table shows the corresponding data types supported by the CJ-series PLCs and the HMIs.

CJ-series data type	HMI data type
BOOL	Boolean
INT	Short
DINT	Integer
LINT	Long
UINT	UShort
WORD	
UINT_BCD	
UDINT	UInteger
DWORD	
UDINT_BCD	
ULINT	Ulong
LWORD	
ULINT_BCD	
REAL	Single
LREAL	Double
STRING	String

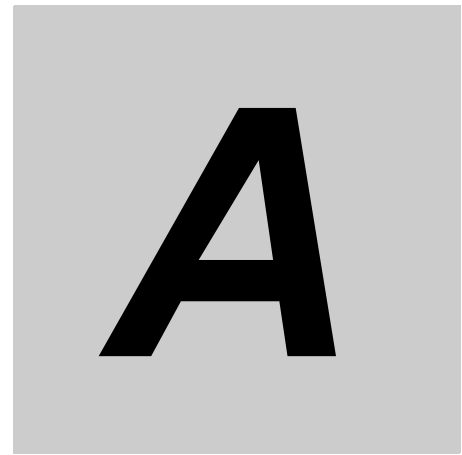

Appendix

This appendix provides reference information for connecting devices.

A-1	Clipboard Format for Device Variable Table Data	A-2
------------	--	------------

A

A-1 Clipboard Format for Device Variable Table Data

The following format is supported.

Format name	Character code	Delimiter	Remarks
UNICODE TEXT	UTF-16LE	Tab (0x0900)	NULL must be used for termination.

1st column	2nd column	3rd column	4th column
Name	Data Type	Comment	AT

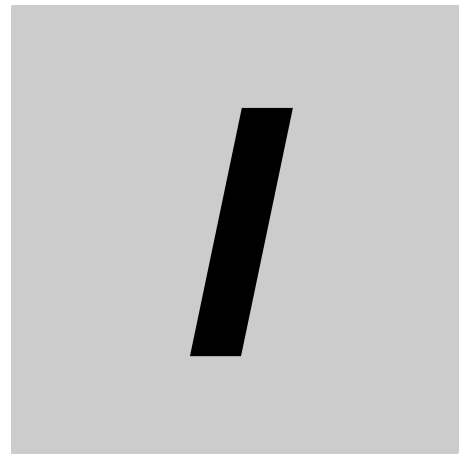

Index

D

data types 3-8, 4-19
device references 3-4, 4-7, 4-15
device variables 3-6, 4-9, 4-17

E

Ethernet switches 2-4
EtherNet/IP 4-12

M

mapping variables 3-8, 4-10, 4-19

N

network installation 2-6

O

OMRON CJ-series PLC 4-1
OMRON NJ-series Controller 3-1

R

range of accessible addresses 4-10

S

supported data types 4-11
supported devices 1-2
system configuration 2-2

T

twisted-pair cables 2-4

OMRON Corporation Industrial Automation Company
Tokyo, JAPAN

Contact: www.ia.omron.com

Regional Headquarters

OMRON EUROPE B.V.

Wegalaan 67-69-2132 JD Hoofddorp
The Netherlands

Tel: (31)2356-81-300/Fax: (31)2356-81-388

OMRON ELECTRONICS LLC

One Commerce Drive Schaumburg,
IL 60173-5302 U.S.A.

Tel: (1) 847-843-7900/Fax: (1) 847-843-7787

OMRON ASIA PACIFIC PTE. LTD.

No. 438A Alexandra Road # 05-05/08 (Lobby 2),
Alexandra Technopark,
Singapore 119967

Tel: (65) 6835-3011/Fax: (65) 6835-2711

OMRON (CHINA) CO., LTD.

Room 2211, Bank of China Tower,
200 Yin Cheng Zhong Road,
PuDong New Area, Shanghai, 200120, China

Tel: (86) 21-5037-2222/Fax: (86) 21-5037-2200

Authorized Distributor:

© OMRON Corporation 2014 All Rights Reserved.
In the interest of product improvement,
specifications are subject to change without notice.

Cat. No. V119-E1-01

0614